

Efka vario dc

CONTROL

AB80A4113

INSTRUCTION MANUAL

WITH PARAMETER LIST

No. 402144

english

Efka
FRANKL & KIRCHNER
GMBH & CO KG

Efka
EFKA OF AMERICA INC.

Efka
EFKA ELECTRONIC MOTORS
SINGAPORE PTE. LTD.

Contents	Page
1. Important Safety Instructions	1
2. Range of Applications	2
2.1 Use in Accordance with Regulations	2
3. Complete Drive Unit Consisting of	2
3.1 Special Accessories	3
4. Operation	3
4.1 Access to Programming on Command Input	3
4.2 The Operator Level	3
4.3 The Technician Level	5
4.3.1 Access to the Technician Level	5
4.3.2 Programming a Parameter	5
5. Starting Service	6
5.1 General Instructions	6
5.2 Initial Operation	7
5.3 Fast Installation by Preset Values	7
6. Functions and Settings	8
6.1 Functions and Settings on the Operator Level	8
6.1.1 Switchable Functions	8
6.1.2 Needle Up/Down	8
6.1.3 Limitation of the Maximum Speed	8
6.2 Functions and Settings on the Technician Level	9
6.2.1 Selection of the Type of Sewing Machine	9
6.2.2 First Slow Stitch After Power On	9
6.2.3 Softstart	9
6.2.4 Thread Trimmer, Thread Tension Release and Thread Wiper	10
6.2.5 Presser Foot Lifting	10
6.2.6 Reversion	11
6.2.7 Blocking of Machine Run (Safety Switch)	11
6.3 Machine Functions	13
6.3.1 Direction of Rotation of the Motor	13
6.3.2 Start Behavior	13
6.3.3 Braking Behavior	13
6.3.4 Braking Power at Standstill	14
6.3.5 Setting the Positions	14
6.3.5.1 Reference Position	14
6.3.5.2 Signal and Stop Positions	16
6.3.6 Supply Voltage 5V and/or 12V	17
6.3.7 External Actuator EB301 and EB302	18

7. Error Messages	18
8. Signal Test	19
8.1 Position Transmitter and Output Tests	19
8.1.1 Position Transmitter Test	19
8.1.2 Output Test	19
8.2 Input Test	20
9. Connection Diagrams	21
10. Function Diagrams	23
10.1 Trimming from Full Machine Run	23
10.2 Trimming from Full Machine Run	24
10.3 Trimming from Intermediate Stop with Reversion	24
10.4 Trimming from Full Machine Run	25
10.5 Trimming from Intermediate Stop with Reversion	25
10.6 Trimming from Full Machine Run	26
10.7 Trimming from Intermediate Stop with Reversion	26
10.8 Trimming from Full Machine Run	27
10.9 Trimming from Intermediate Stop in Position 2	27
10.10 Trimming from Full Machine Run	28
10.11 Trimming from Intermediate Stop with Reversion	28
10.12 Thread Trimmer Off	29
10.13 Blocking of Machine Run / Needle Up/Down	29
11. Parameter List	30
12. Operating Elements and Socket Connectors	33

1. Important Safety Instructions

When using an EFKA drive and accompanying appliances (e.g. for sewing machines), basic safety precautions should always be followed, including the following:

- Read all instructions thoroughly before using this drive.
 - Drive and accompanying appliances should be mounted and put into operation by qualified personnel in accordance with the guidelines provided in the instruction manual.
- To reduce the risk of burns, fire, electric shock, or personal injury:**
- Use this drive only for its intended use as described in the instruction manual.
 - Use only attachments recommended by the manufacturer or as contained in the instruction manual.
 - Do not operate without corresponding protective devices.
 - Never operate this drive if one or more parts (e.g. cables, plugs) are damaged, if it is not working properly, if any damages can be identified or are to be suspected (e.g. after it has been dropped). Only qualified personnel are authorized to make adjustments, eliminate faults and complete repair work.
 - Never operate the drive with the air openings blocked. Keep ventilation openings of the drive free from the accumulation of lint, dust and loose cloth.
 - Never drop or insert any object into any opening.
 - Do not use drive outdoors.
 - Do not operate where aerosol (spray) products are being used or where oxygen is being administered.
 - To disconnect, turn off main switch, then remove plug from outlet.
 - Do not unplug by pulling on cord. To unplug, grasp the plug, not the cord.
 - Keep fingers away from all moving machine parts. Special care is required e.g. around the sewing machine needle and the V-belt.
 - Before mounting and adjusting accompanying appliances, i.e. positioner, reversing device, light barrier, etc., disconnect drive from mains (turn off main switch, remove mains plug from outlet [DIN VDE 0113 part 301; EN 60204-3-1; IEC 204-3-1]).
 - Always switch off (0) machine and remove plug from outlet, when removing covers, mounting accompanying appliances, positioner especially, light barrier, etc., or any other devices mentioned in the instruction manual.
 - Only qualified personnel are authorized to work on the electrical components.
- Work on high voltage circuit areas is forbidden, except as stated in the respective regulations, e.g. DIN VDE 0105 part 1.
 - Only specially trained personnel are authorized to complete repair work.
 - Cables to be wired must be protected against expectable strain and fastened adequately.
 - Cables near moving machine parts (e.g. V-belts) must be wired at a minimum distance of 25 mm (see DIN VDE 0113 part 301; EN 60204-3-1; IEC 204-3-1).
 - For safety it is preferred to wire the cables separately from each other.
 - Before connecting the mains line make sure that the mains voltage corresponds to the specifications on the motor rating plate and on the nameplate of the power pack.
 - Connect this drive to a properly grounded outlet only. See Grounding Instructions.
 - Electric accompanying appliances and accessories must only be connected to safety low voltage.
 - EFKA DC drives are protected according to overvoltage class 2 (DIN VDE 0160 § 5.3.1).
 - Observe all safety guidelines before undertaking conversions or modifications.
 - For repair and maintenance use only original replacement parts.



Warnings in the instruction manual which point out particular risks of personal injury or risk to the machine are marked with this symbol wherever applicable.



This symbol is a warning on the control and in the instruction manual. It indicates hazardous voltage.

CAUTION - In the case of failure this area can be current-carrying even after having turned the power off (non discharged capacitors).

- The drive is not an independently operating unit, but is designed to be incorporated into other machinery. It must not be put into service until the machinery into which it is to be incorporated has been declared in conformity with the provisions of the EC Directive.

Save these instructions for future reference.

2. Range of Applications

The drive is suitable for:

- Lock stitch and chain stitch sewing machines by various manufacturers

2.1 Use in Accordance with Regulations

The drive is not an independently operating machine, but is designed to be incorporated into other machinery. It must not be put into service until the machinery into which it is to be incorporated has been declared in conformity with the provisions of the EC Directive (Appendix II, paragraph B of the Directive 89/392/EEC and supplement 91/368/EEC).

The drive has been developed and manufactured in accordance with the respective EC standards:

EN 60204-3-1:1990 Electric equipment of industrial machines:
special requirements for industrial sewing machines,
sewing units and sewing systems.

The drive can only be operated:

- on thread processing machines
- in dry areas

3. Complete Drive Unit Consisting of

1	Direct current motor	DC....
1	Control	vario dc AB80A4113
	- Power pack	N153 (optional N155)
	- Actuator	EB301 (optional EB302, reduced actuating force)
1	Position transmitter	P6-1
1	Mains switch	NS105
1	Set of standard accessories consisting of:	B131 belt guard, complete set of hardware motor foot bracket 1 and 2, short documentation
1	Set of accessories consisting of:	Z4 pitman rod, complete 3-pin plug (Mas3100) with slide index 10-pin plug (Mes100)
1	Pulley	

3.1 Special Accessories

Solenoid type EM1. (for e.g. presser foot lifting, etc.)	- available versions see specification "Solenoids"
Extension cable for external actuator, approx. 750 mm long, complete with plug and socket connector	- part no. 1111845
Extension cable for external actuator, approx. 1500 mm long, complete with plug and socket connector	- part no. 1111787
5-pin plug (Mas 5100W) with slide index for the connection of another external actuator	- part no. 0501278
Foot control type FB302 for standing operation with approx. 1400 mm connecting cable and plug	- part no. 1460018
Potential equalization cord 700 mm long, LIY 2.5 mm ² , grey, with forked cable brackets on both sides	- part no. 1100313
Fitting piece for position transmitter	- part no. 0300019
Extension cable for position transmitter P6-., approx. 1100 mm long, complete with plug and socket connector	- part no. 1100409
Adapter cord for the connection to Singer class 591 (for Nähschuster)	- part no. 1100336
Extension cable for commutation transmitter, approx. 315 mm long, complete with plug and socket connector	- part no. 1111229
Extension cable for commutation transmitter, approx. 1100 mm long, complete with plug and socket connector	- part no. 1111584
Extension cable for motor connection, approx. 400 mm long	- part no. 1111858
Extension cable for motor connection, approx. 1500 mm long	- part no. 1111857
Pulley 40 mm ϕ with special belt intake and slip-off protection (use SPZ belt)	- part no. 1112223
Pulley 50 mm ϕ with special belt intake and slip-off protection (use SPZ belt)	- part no. 1112224
Knee switch type KN3 (pushbutton) with cord of approx. 950 mm length without plug	- part no. 58.0013
Sewing light transformer	- please indicate line voltage and sewing light voltage (6.3V or 12V)
3-pin plug (Mas 3100) with slide index	- part no. 0500402
10-pin plug (Meb 100)	- part no. 0500357

4. Operation

4.1 Access to Programming on Command Input

In order to prevent the unintentional modification of preset functions the input commands are distributed at two levels.

The following persons have access:

- the operator to the first level
- the technician to both levels

4.2 The Operator Level

On this level simple functions which have to be changed frequently during operation can easily be switched on or off and/or changed by the operator.

For example, basic position needle up/down, presser foot lifting at seam end automatically on/off.

This level is always accessible when power is on, unless the technician level is open.

Note:

A changed (switched) function will only be permanently saved by a new sewing start before turning power off.

4.3 The Technician Level

On this level fundamental functions can be programmed.

4.3.1 Access to the Technician Level

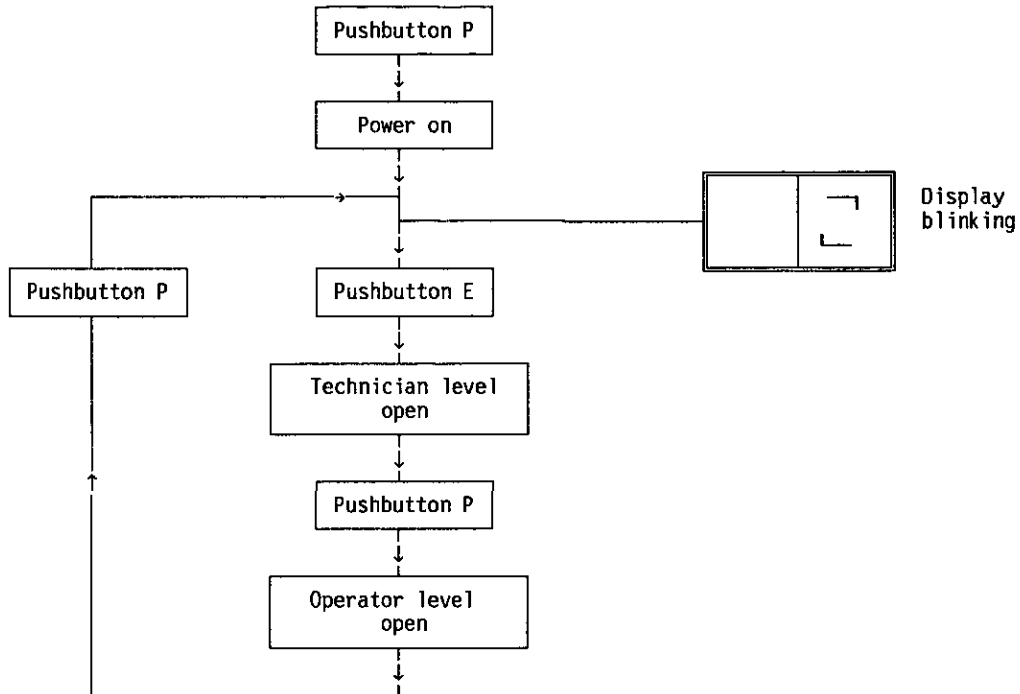

4.3.2 Programming a Parameter

1. Open technician level

Press **P** + TURN POWER ON

Display blinks ==>

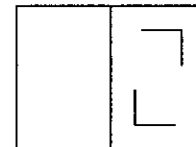

2. Set parameters

E

Parameter A ==>
= Setting the reference point

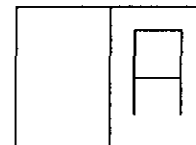

The desired parameter level can be selected by pressing pushbutton E repeatedly. The respective abbreviation appears on the display. See also chapter -Parameter List-

3. Change parameter value



Displayed value ==>
e.g. 10

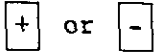
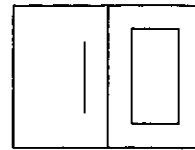

==> Change value

On with step 2.



==> Address next parameter
or 4. Close technician level

4. Close technician level



Display goes off ==>

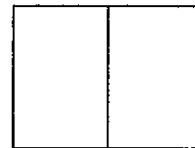

5. Saving a changed value

A changed setting is permanently saved only after the sewing start before turning power off.

Note:

A new entry into the technician level is now possible by repeatedly pressing pushbutton P. The display shows the blinking programming mark. By pressing pushbutton E the last parameter programmed appears on the display.

5. Starting Service

5.1 General Instructions

When putting the control into operation, programming has to be done in the following manner:

- Set the direction of rotation of the motor (parameter "N")
- If necessary, set the reference position (parameter "A")
- If necessary, set the positions (parameters "B", "C", "D")
- If necessary, set the speeds (parameters "E", "F", "G", "H")
- If necessary, set the remaining relevant parameters
- Start sewing in order to save the set values

Note:

If the power is turned off the adjustments made before starting to sew get lost.



Attention!

If the direction of rotation of the motor is changed the positions must be reprogrammed.

5.2 Initial Operation

The instructions for initial operation are valid under the following conditions only:

- The positions must not have been reprogrammed.
- The direction of rotation of the motor shaft must be set to "counterclockwise rotation".
- Before mounting the position transmitter, the sewing machine shaft is to be set to the reference position.
- Markings on the position transmitter shaft and on the position transmitter housing have to be aligned, then mount the position transmitter on the sewing machine shaft.
- If necessary, set the speeds (parameters "E", "F", "G", "H").
- If necessary, set the remaining relevant parameters.
- Start sewing in order to save the set values.

Note:
If the power is turned off the adjustments made before starting to sew get lost.

5.3 Fast Installation by Preset Values

Fast setting of the functions at values preprogrammed in the factory is possible by using this function. (see parameter list)

Exception: direction of rotation and positions

1. Turn power off

2. Press P + TURN POWER ON

Display blinks ==>

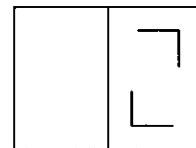

3. Press - for about 5 seconds

until 00 appears on the display ==>

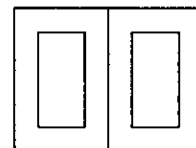

4. Press + or - several times

until 76 appears on the display ==>

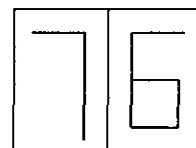

5. Press P briefly (< 2sec.)

Display goes off ==>

The drive is ready for operation on the operator level

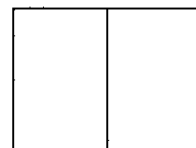

6. Press P longer (> 2sec.)

Display blinks ==>

The technician level is open for further programming

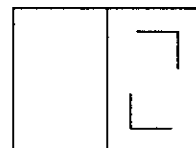

6. Functions and Settings

6.1 Functions and Settings on the Operator Level

6.1.1 Switchable Functions

Switchable functions can be changed by pushbutton. The switching state is indicated by corresponding light emitting diodes (LED).

Table: Allocation of functions for the pushbuttons and LEDs

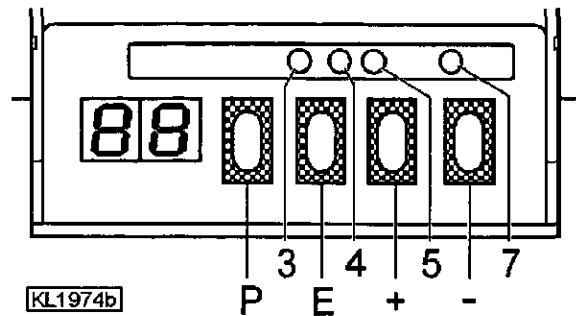

Function	Pushbutton	LED No. = on	LED No. = off
Presser foot lifting at stop in the seam (automatic)	E	3 = on	3 = off
Presser foot lifting at the seam end (automatic)	E	4 = on	4 = off
Thread trimmer, thread tension release and thread wiper	+	5 = on	5 = off
Basic position (at stop in the seam)	-	7 = POS2 (Needle up)	7 = POS1 (Needle down)

6.1.2 Needle Up/Down

When actuating the external pushbutton for needle up/down, the drive runs to the respective opposite position. For safety reasons this function is activated only if the needle is in one of the possible stop positions (position 1 or position 2).

If the presser foot is lifted it will be lowered before the change of positions.

6.1.3 Limitation of the Maximum Speed

By pressing the + or - pushbuttons, or while the motor is running, the programmed maximum speed can be changed. A limitation to approx. 50% of the programmed value is possible.

The activated speed limitation is shown on the display.

-	1	Limitation approx. 10%
:	:	:
-	5	Limitation approx. 50%

Note:

The changed setting is permanently saved only after trimming and a new sewing start.

6.2 Functions and Settings on the Technician Level

6.2.1 Selection of the Type of Sewing Machine

Functions	Parameter
Lockstitch mode 1	Q = 01
Lockstitch mode 2	Q = 02
Lockstitch mode 3	Q = 03
Lockstitch mode 4	Q = 04
Chainstitch mode 1	Q = 05
Chainstitch mode 2	Q = 06

The control AB80A is suitable for the operation of various types of sewing machines.

The adaptation of the different functional sequences and outputs for solenoids and valves can be programmed.



Attention!

When using a different type of sewing machine, all respective settings must be reprogrammed. This is of special importance for the settings mentioned in chapter **Starting Service**.

6.2.2 First Slow Stitch After Power On

Functions	Parameter
Slow stitch after power on ON/OFF	W

For the protection of the sewing machine and when the function is on, the first stitch after power on will be performed at positioning speed, independently of the function Softstart.

6.2.3 Softstart

Functions	Parameter
Number of Softstart stitches	I
Softstart speed	H
Softstart on/off	PC

Function:

- after power on
- at the beginning of a new seam
- speed limited (can be set by parameters), controlled by the pedal
- stitch counting is synchronized to position 1
- interruption by pedal in position 0 (neutral)
- exit by full heelback (position -2)

After power on the first stitch will be performed at positioning speed, independently of the Softstart setting, if the function "slow stitch after power on" is turned on.

The Softstart sequence is not affected by this operation.

6.2.4 Thread Trimmer, Thread Tension Release and Thread Wiper

Functions	Parameter
Thread trimming speed	F
Operating time of the thread wiper/ blow wiper	J
Operating time of the thread trimmer in the chainstitch mode (mode 5,6)	S
Activation delay of presser foot lifting after thread wiping (mode 1...5)	K
Activation delay of the blow wiper (mode 6)	K

The above parameters can be set in order to optimize the execution of the seam end. Their effect can, in some cases, vary in the different modes.

6.2.5 Presser Foot Lifting

Functions	Parameter
Start delay from lifted foot	T
Activation delay of presser foot lifting after thread wiping (mode 1...5)	K
Activation delay of presser foot lifting at the seam end (mode 6)	U
Pulse width for pulsing	PB

The connection of electromagnetic or electropneumatic presser foot lifting is possible.

Foot is lifted:

- in the seam - by heelback (position -1)
 or automatically (LED 3 = on)
- after thread trimming - by heelback (position -1 or -2)
 or automatically (LED 4 = on)

The programmed time in parameter "U" will be 0, if the thread trimming is switched off.

Holding power of the lifted foot:

The presser foot is lifted by full power (approx. 500ms). Then the solenoid is switched to partial power in order to reduce the load for the control and for the connected solenoid.
The holding power at partial power can be set by parameter PB.



Caution!

If the holding power is set too high the solenoid and the control may be permanently damaged. Please observe the allowed operating time of the solenoid and set the appropriate value according to the following table.

Stage	Operating time	Effect
1	12.5 %	low holding power
2	25 %	
3	37.5 %	
4	50 %	
5	62.5 %	
6	75 %	
7	87.5 %	high holding power
0	100 %	full power

Foot lowers:

- from manual foot lifting, when pedal is in position 0 (neutral) (position ≥ 0)
- from automatic foot lifting, when pedal pushed forward (position > 0)

The start is delayed until the foot has securely lowered.

- delay time can be set (param. T)

6.2.6 Reversion

Functions	Parameter
Number of reversion increments	L
Activation delay of reversion	M
Positioning speed	E

The function "reversion" is performed after trimming.

When the stop position is reached, the drive stops for a time that can be set by parameter M. Then it reverses at positioning speed for a number of increments that can be set (param. L).

1 increment corresponds to approx 0.7°.

6.2.7 Blocking of Machine Run (Safety Switch)



Attention!
 This is not a safety function.
 The line voltage must still be switched off during maintenance and repair work.

Functions	Parameter
Blocking of machine run (safety switch), active when switch closed (make contact [N.O.])	V = 00
Blocking of machine run (safety switch), active when switch open (break contact [N.C.])	V = 01

Blocking of machine run (safety switch) is activated by an external switch. The use of a make contact (N.O.) or a break contact (N.C.) is possible by programming parameter "V".
The activated blocking of machine run (safety switch) is shown on the display:

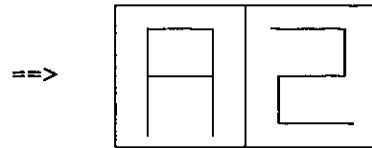

If the blocking of machine run (safety switch) is activated at machine standstill the start is blocked.
- Presser foot lifting is possible.

If the blocking of machine run (safety switch) is activated during sewing the drive stops in the basic position.
- Presser foot lifting is possible.

A new start after deactivation is only possible if the pedal was in position 0 (neutral) before.

6.3 Machine Functions

6.3.1 Direction of Rotation of the Motor

Functions	Parameter
Direction of rotation of the motor	N

Look at the motor shaft: Parameter "N" = 00 - clockwise rotation
 Parameter "N" = 01 - counterclockwise rotation



Attention!

If the motor is mounted differently, e.g at a different angle or with gear, ensure that the parameter value is assigned correctly to the direction of rotation.

6.3.2 Start Behavior

Functions	Parameter
Starting edge	PD

The drive accelerating dynamics can be adapted to the characteristic of the sewing machine (light, heavy).
 - High setting value = high acceleration

With a high starting edge setting value and, in addition, possibly high braking parameter values on a light machine, the behavior may appear coarse. In this case, one should try to optimize the settings.

Incorrect setting can cause the drive to lock or not to reach the set speed. In this case, the drive stops and the display shows an error message.

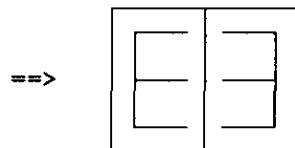

6.3.3 Braking Behavior

Functions	Parameter
Braking parameter 1 Braking parameter 2	PE PF

The braking effect of the drive can be set.
 The following applies to all setting values:
 The higher the value the more aggressive the braking reaction!

Parameter PE influences the slowing down, when a slight change of the speed is desired (changing the pedal position by less than 5 pedal steps, e.g. from step 10 to step 6).

Parameter PF influences the slowing down, when a major change of the speed is desired (changing the pedal position by more than 4 pedal steps, e.g. for positioning from step 12 to step 0).

6.3.4 Braking Power at Standstill

Functions	Parameter
Braking power at standstill	0

This function prevents unintentional "wandering" of the needle at standstill. The effect can be tested by turning the handwheel.

- The braking power works at standstill
 - at stop in the seam
 - after trimming
- The effect can be set
- The higher the set value, the higher the braking power
- It does not work after power on, unless sewing has not been started

6.3.5 Setting the Positions

Functions	Parameter
Reference position	A
Position 1 (lower needle position)	B
Position 2 (upper needle position)	C
Position 1A (second internal switching point for the slot between position 1 and 1A)	D

6.3.5.1 Reference Position

The angular positions necessary on the machine, e.g. for needle down position or thread lever up position are stored in the control as numerical or angular values.

In order to establish a relationship between the electric position transmitter information and actual mechanical position a reference position is needed.

The reference position must be set:

- for initial operation
- after changing the position transmitter
- after changing the microprocessor

Programming:**1. Open the technician level**

Press **P** + TURN POWER ON

Display blinks ==>

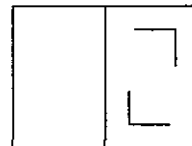
**2. Address parameter**

Press **E**

Parameter A is displayed ==>
= Setting the reference point

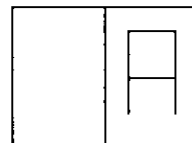
**3. Prepare setting**

Press **+**

Display 0 blinking ==>

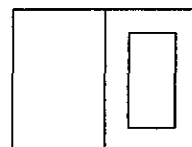
**4. Setting**

- Turn handwheel until display 0 is constant.
- Turn handwheel in the direction of rotation and set to a value indicated by the sewing machine manufacturer.

Note:
Reference position = needle point at the height of the needle plate, from downward movement of the needle in the direction of rotation of the motor shaft.

5. Enter setting

Press **E**

Display changes to next parameter, here from A to B. ==>

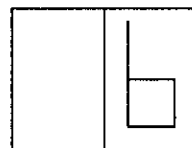
**6. Exit programming**

Press **P**

(Technician level closed)

Display goes off ==>

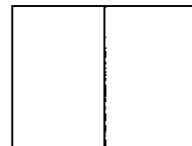
**7. Save programmed settings**

A changed setting is saved only after the sewing start before turning power off.

Note:
A new entry into the technician level is now possible by pressing pushbutton P again.
The display shows the blinking programming mark. By pressing pushbutton E the last parameter programmed appears on the display.

6.3.5.2 Signal and Stop Positions

The values of the signal and stop positions are factory set. After setting the reference position, the machine is ready for operation. Settings only need to be changed on non-standard machines and/or for fine tuning.

If necessary, the signal and stop positions can be set as described in chapter "Reference Positions" from step 3 onwards.

In this case pushbutton E must be pressed several times after opening the technician level until the parameter for the desired position appears on the display.

Set position 1

- Actual display = Parameter B

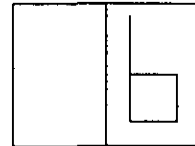

- Press + drücken Display for "Set position 1" blinks

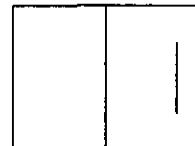

- Set position 1 by turning the handwheel
 - or press E to change to the next parameter

- Press E to enter the setting ==> Display changes to the next parameter "C"

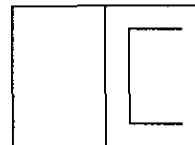

Set position 2

- Actual display = Parameter C



- Press + Display for "Set position 2" blinks

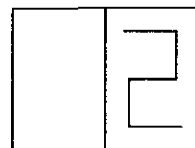



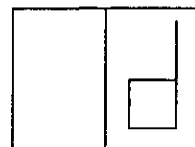

- Set position 2 by turning the handwheel
 - or press E to change to the next parameter

- Press E to enter the setting ==> Display changes to the next parameter "D"

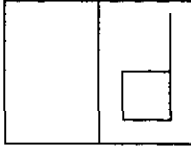

Set position 1A

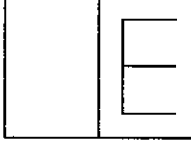
- Actual display = Parameter D 
- Press  Display for "Set position 1A" blinks 
- Set position 1a by turning the handwheel
 - or press  to change to the next parameter
- Press  to enter the setting ==> Display changes to the next parameter "E" 

Setting the positions is completed.

6.3.6 Supply Voltage 5V and/or 12V

For external devices as for ex. thread monitor, there is a supply voltage of +5V on socket B5/4. After opening the cover, this voltage can be changed to +12V by moving a jumper on the printed circuit board to a different position.



Attention!
Before opening the cover, turn power off and remove mains plug from outlet!

- +5V = Connect top pins 1 and 2 with jumper (factory setting)
- +12V = Connect bottom pins 3 and 4 with jumper

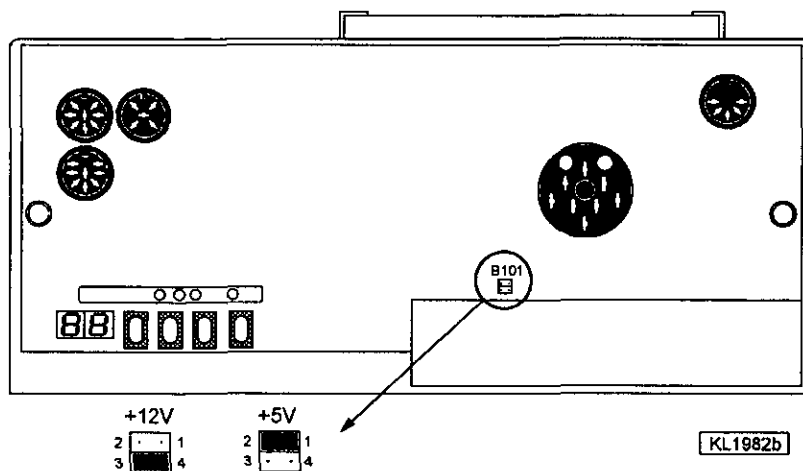

6.3.7 External Actuator EB301 and EB302

With the help of the external actuator connected with the pedal the commands for the sewing operation are inputted. Instead of the external actuator connected to the socket connector B80 (see chapter Socket Connectors) another external actuator can be connected.

The external actuator EB302 has softer springs than EB301. This means that a lower actuating force is needed.

Table: Coding of the pedal steps

Pedal step	D	C	B	A		
-2	H	H	L	L	Full heelback	(e.g. initiating the seam end)
-1	H	H	H	L	Slight heelback	(e.g. presser foot lifting)
0	H	H	H	H	Pedal in position 0 (neutral)	
$\frac{1}{2}$	H	H	L	H	Pedal slightly forward	(e.g. presser foot lowering)
1	H	L	L	H	Speed stage 1	(ⁿ pos)
2	H	L	L	L	.	
3	H	L	H	L	.	
4	H	L	H	H	.	
5	L	L	H	H	.	
6	L	L	H	L	.	
7	L	L	L	L	.	
8	L	L	L	H	.	
9	L	H	L	H	.	
10	L	H	L	L	.	
11	L	H	H	L	.	
12	L	H	H	H	Speed stage 12 (Pedal fully forward)	(ⁿ max)

L = switch contact closed, H = switch contact open

7. Error Messages

General Information

Display	Signification
A1	Pedal not in neutral position, when switching the machine on
A2	Blocking of machine run (safety switch)

Serious Situation

Display	Signification
E1	Position transmitter not connected or defective
E2	Time between power off and power on too short
E3	Machine locks, or does not reach the desired speed
E4	Control disturbed by deficient grounding or loose contact

Hardware Disturbance

Display	Signification
H1	Commutation transmitter cord or frequency converter disturbed
H2	Processor disturbed

8. Signal Test

8.1 Position Transmitter and Output Tests

Functions	Parameter
Test function position transmitter and outputs	PH

The functions of the position transmitter and of the outputs can be tested by a routine that can be activated by parameter PH.

8.1.1 Position Transmitter Test

The functions are indicated by light emitting diodes on the control panel.

- Address parameter PH
- Start sewing and trim
- Press the + pushbutton
- Turn handwheel
 - when reaching a position, the light emitting diodes are switched on
 - when leaving a position, the light emitting diodes are switched off
- LED 5 = on- angular position between position 1 and 1A
- in addition LED 3 = on, signal output position 1 switched
- LED 7 = on- angular position between position 2 and 2A
- Press pushbutton P or E to exit the test mode



8.1.2 Output Test

The function is indicated on the display.

For testing, the outputs below are briefly activated.

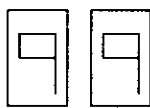
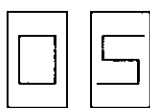
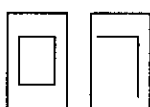
- Address parameter PH
- Press the + pushbutton; the following messages are shown on the display:

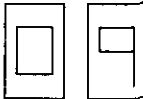
OK		All outputs o.k.
99		Error localization not possible
05		Error on B5/7-8 M3
07		Error on B3/2-3 M2

08		Error on B5/7-10 M1
09		Error on B5/3-5 M4
18		Error on B13/5 Signal output presser foot lifting

If several output errors are identified they are displayed one after the other, alternating automatically.

Exit output test: Press pushbutton P or E

8.2 Input Test

Functions	Parameter
Test function inputs	PI

The input function can be tested by a routine that can be activated by parameter PI.

When the test function is activated, the actual switching state of the connected pushbuttons and switches is read and the message 00 is shown on the display.

If the switching state of a switch changes this is indicated by a code allocated to the input.

Only one switch at a time may switch its switching state.

Test sequence

- Address parameter PI
- Press the + pushbutton; the following messages are shown on the display:

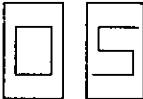
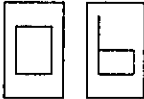
00		No change of the switching state
05		Input B10/2-3 was switched Needle up/down
06		Input B5/6-9 was switched Blocking of machine run

Exit input test: Press pushbutton P or E

9. Connection Diagrams

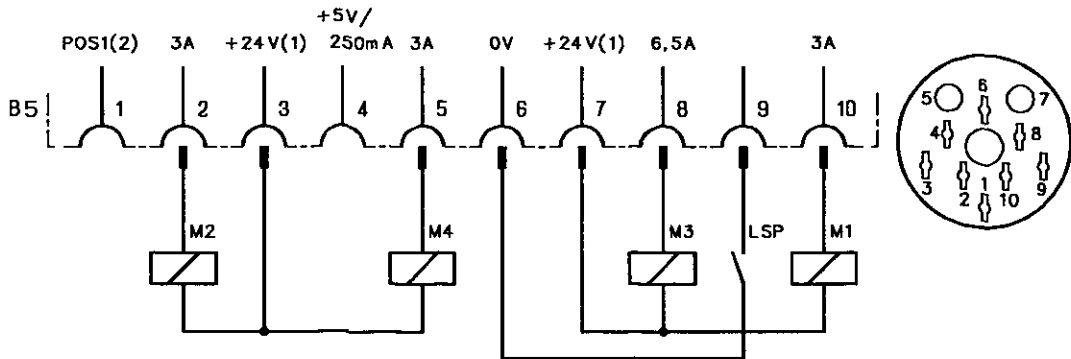

B11039

Lockstitch mode 1 (Parameter Q = 01)	M1 - Thread trimmer (FA1) M2 - Thread wiper (FW) M3 - Presser foot lifting (FL) M4 - Thread tension release (FSPL)
Lockstitch mode 2 (Parameter Q = 02)	M1 - Thread trimmer (FA1) M2 - Thread wiper (FW) M3 - Presser foot lifting (FL) M4 - Motor running (ML)
Lockstitch mode 3 (Parameter Q = 03)	M1 - Thread trimmer (FA2) M2 - Thread wiper (FW) M3 - Presser foot lifting (FL) M4 - Motor running (ML)
Lockstitch mode 4 (Parameter Q = 04)	M1 - Thread trimmer (FA1+FA2) M2 - Thread wiper (FW) M3 - Presser foot lifting (FL) M4 - Motor running (ML)
Chainstitch mode 1 (Parameter Q = 05)	M1 - Thread trimmer (FA) M2 - Thread wiper (FW) M3 - Presser foot lifting (FL) M4 - Motor running (ML)
Chainstitch mode 2 (Parameter Q = 06)	M1 - Thread trimmer (FA) M2 - Blow wiper (BW) M3 - Presser foot lifting (FL) M4 - Motor running (ML)



Attention!
When connecting the outputs, ensure that a total power of 96VA constant load will not be exceeded !

LSP - Blocking of machine run
M1...M4 - The function of the outputs is adapted to the type of sewing machine by programming (Parameter Q) - See table.

- 1) Nominal voltage 24V, no-load voltage max. 36V.
- 2) Counting signal (1/rotation), synchronized to position 1. Transistor output with open collector, max. 40V, 100mA. After power on, the signal is suppressed. It is activated when starting to sew.
- 3) Output +5V / 250 mA (can be changed to 12V / 250 mA after opening the cover).

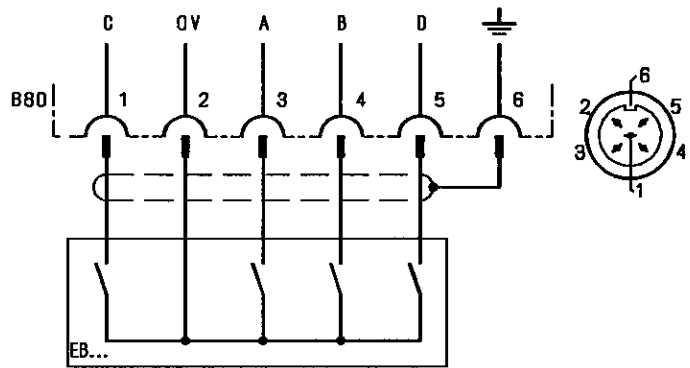
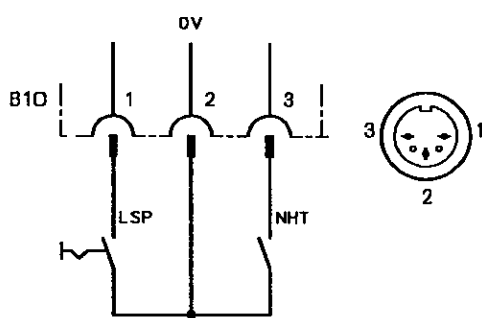

B11040a

- EB** - External actuator
LSP - Switch for blocking of machine run
NHT - Pushbutton for needle up/down

10. Function Diagrams

10.1 Trimming from Full Machine Run

Lockstitch mode 1 (Parameter Q = 1)

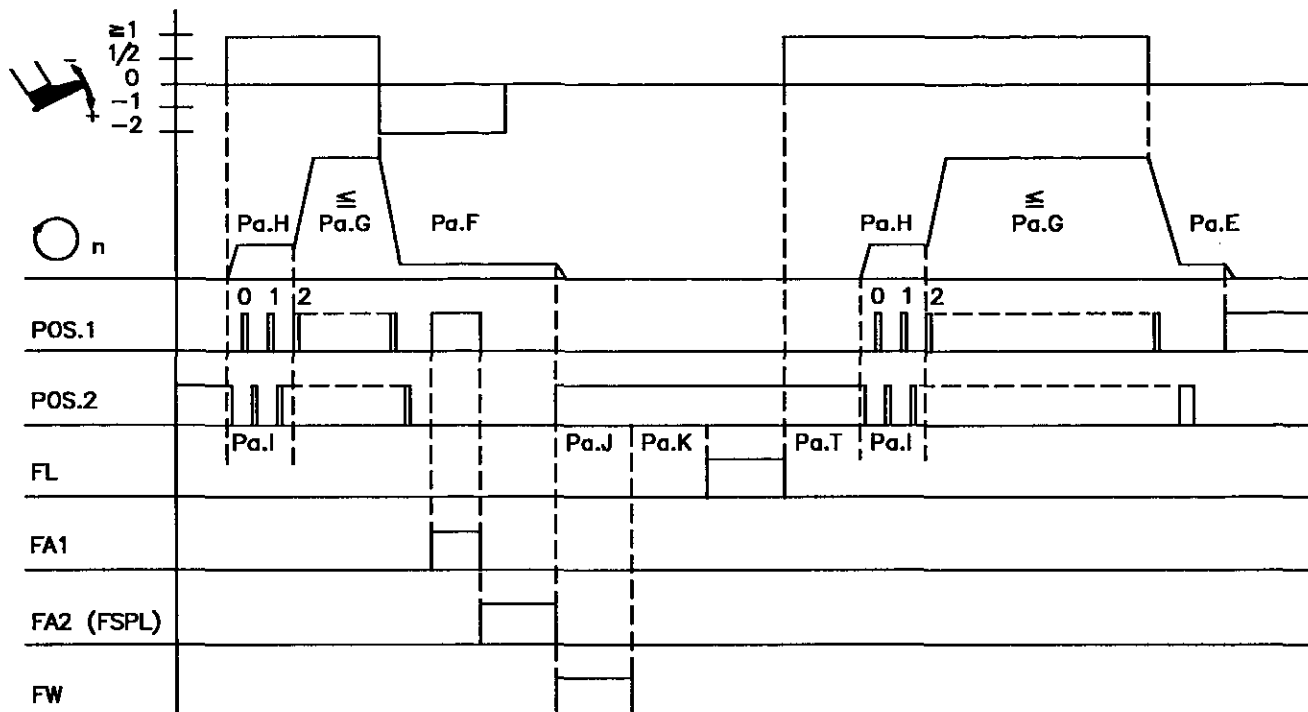

0210/STEPP1

Parameter	Function	
PC	Softstart	on
E	Positioning speed	
F	Thread trimming speed	
G	Maximum speed	
H	Softstart speed	
I	Number of Softstart stitches	
J	Operating time of the thread wiper	
K	Activation delay of presser foot lifting after thread wiping	
L	Number of reversion increments	
M	Activation delay of reversion	
S	Operating time of the thread trimmer in the chainstitch mode (mode 5, 6)	
T	Start delay from lifted foot	
U	Activation delay of presser foot lifting at the seam end (mode 6)	
PB	Pulse width of presser foot lift pulsing	
t2	Activation delay of presser foot lifting	fixed
t4	Time of full power of presser foot lifting	fixed

- Abbreviations:
- FL = Presser foot lifting
 - FA = Thread trimmer
 - FSPL = Thread tension release
 - FW = Thread wiper
 - BW = Blow wiper
 - ML = Motor running
 - Pa. = Parameter...

10.2 Trimming from Full Machine Run

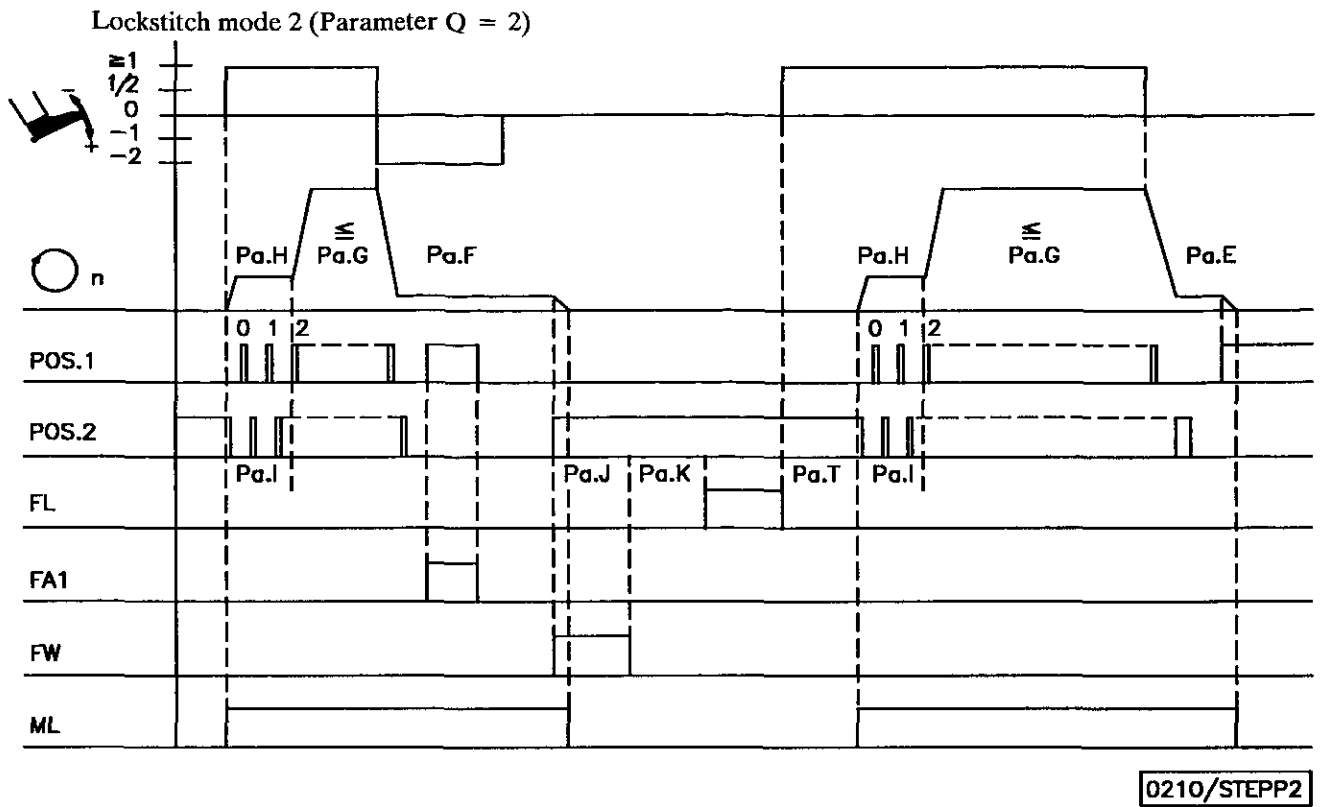

10.3 Trimming from Intermediate Stop with Reversion

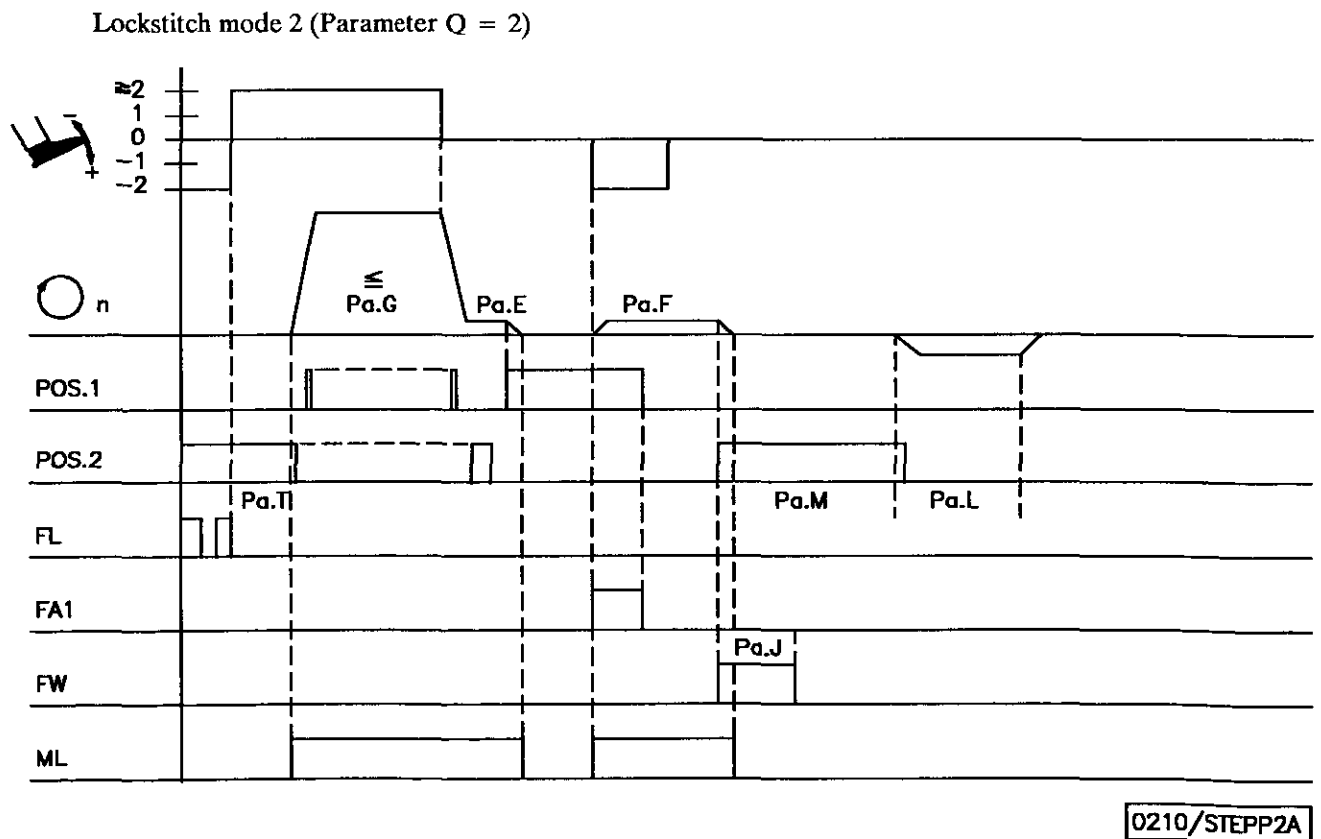
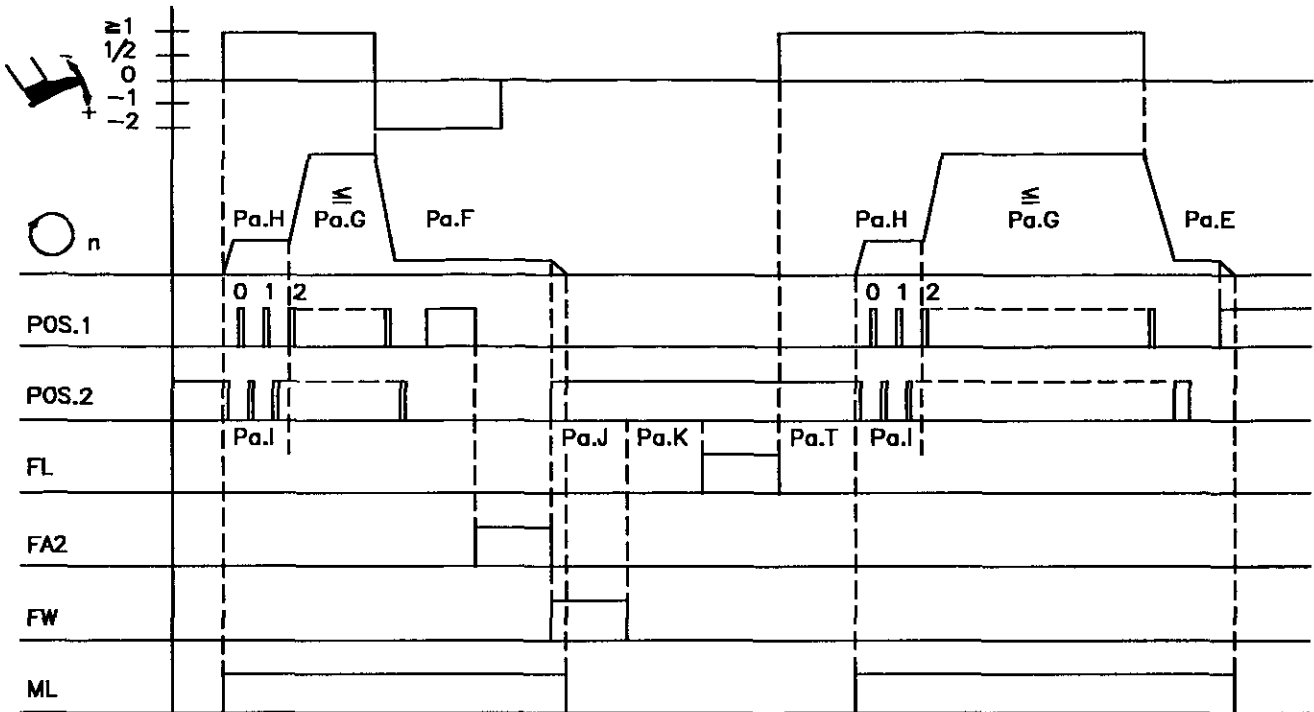

Table of parameters and abbreviations see beginning of chapter

10.4 Trimming from Full Machine Run

Lockstitch mode 3 (Parameter Q = 3)



0210/STPEP3

10.5 Trimming from Intermediate Stop with Reversion

Lockstitch mode 3 (Parameter Q = 3)

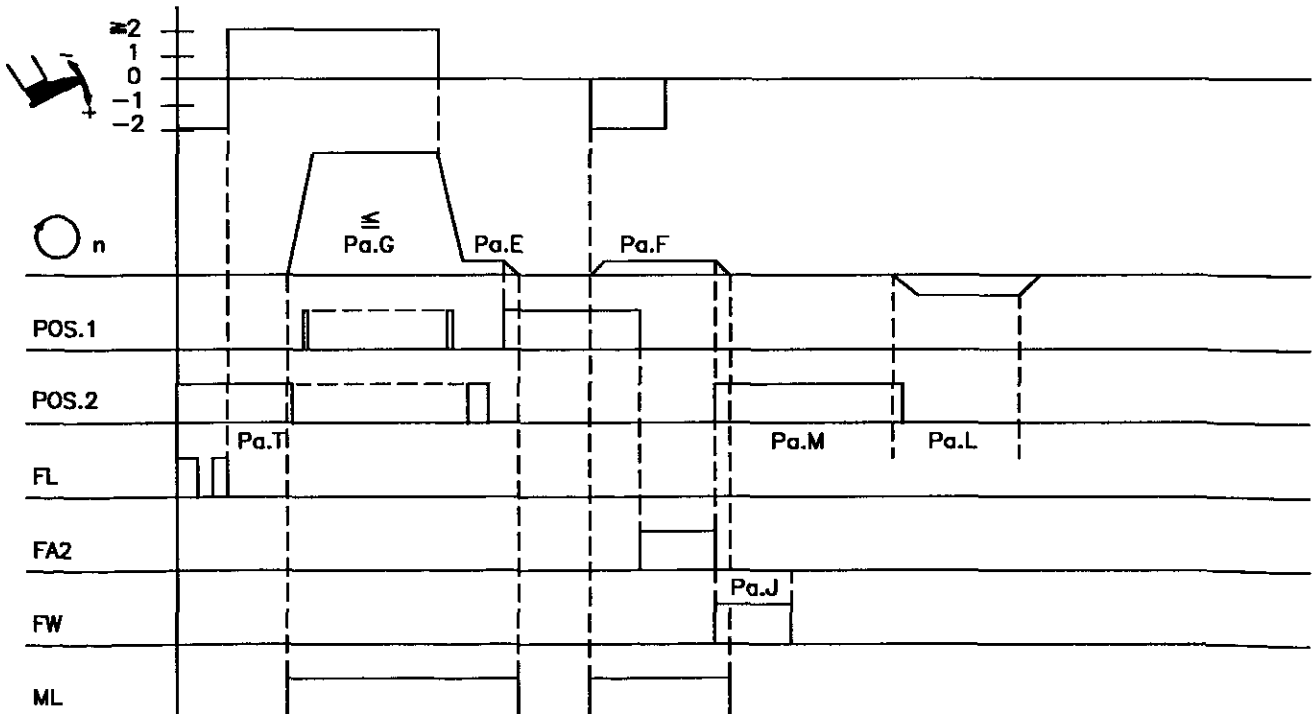

0210/STPEP3A

10.6 Trimming from Full Machine Run

Lockstitch mode 4 (Parameter Q = 4)

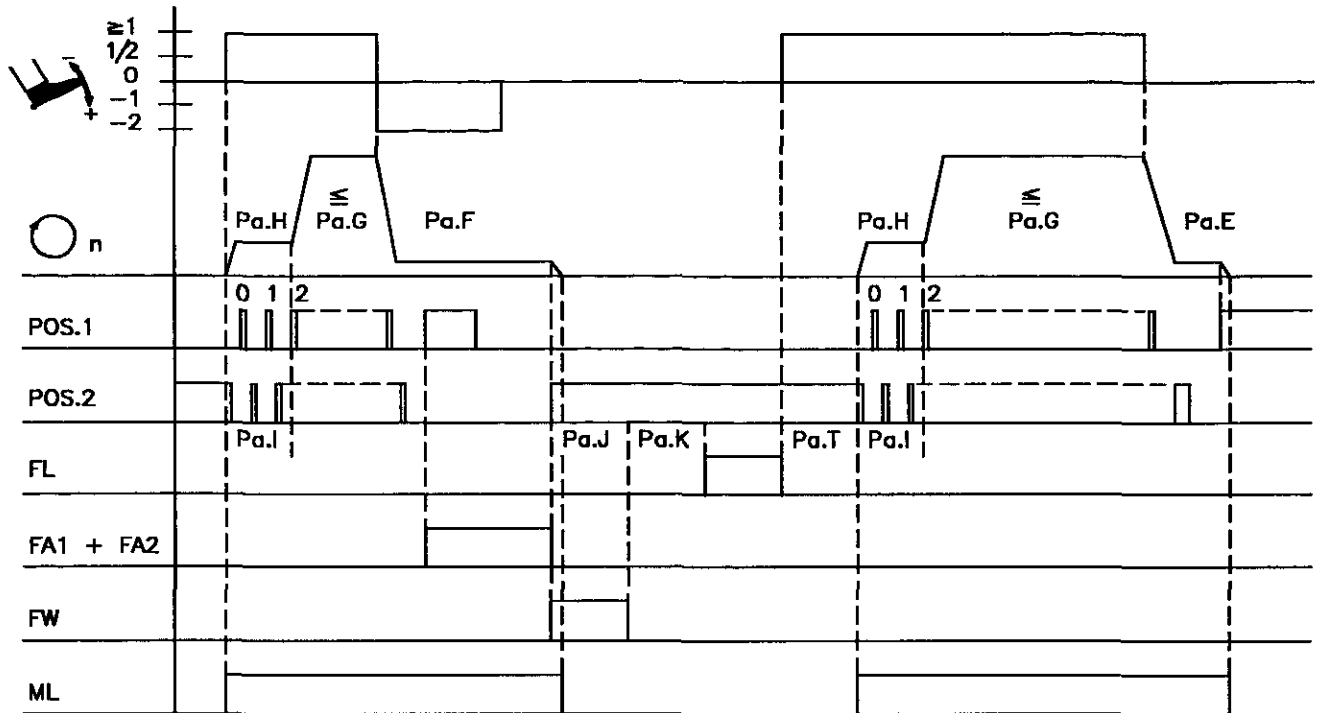

0210/STEPP4

10.7 Trimming from Intermediate Stop with Reversion

Lockstitch mode 4 (Parameter Q = 4)

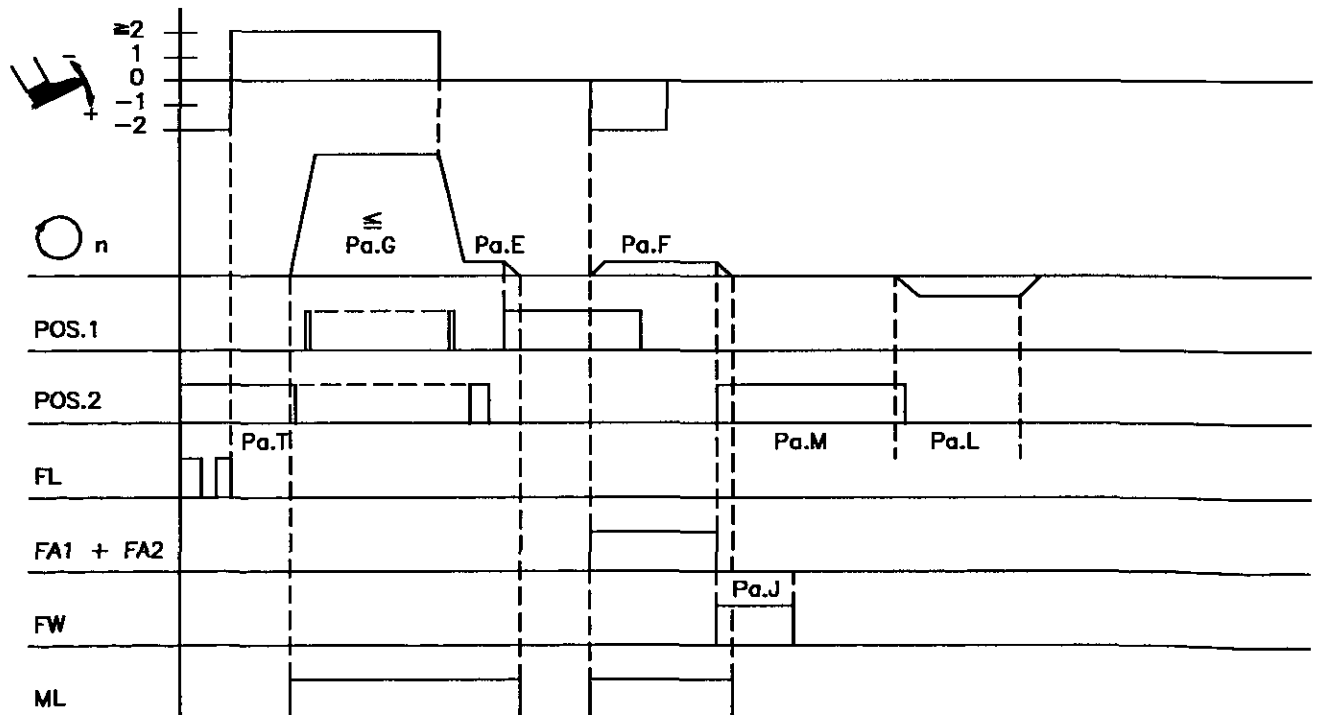

0210/STEPP4A

10.8 Trimming from Full Machine Run

Chainstitch mode 1 (Parameter Q = 5)

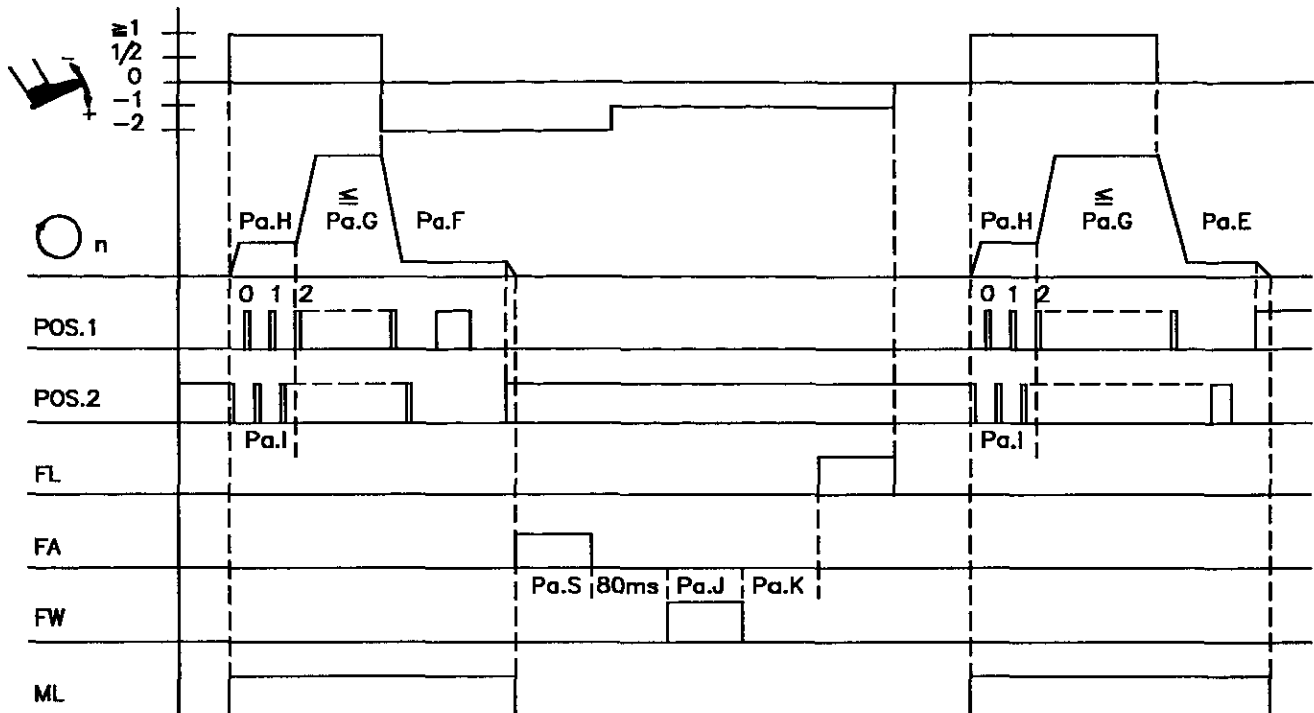

0210/KETTE1

10.9 Trimming from Intermediate Stop in Position 2

Chainstitch mode 1 (Parameter Q = 5)

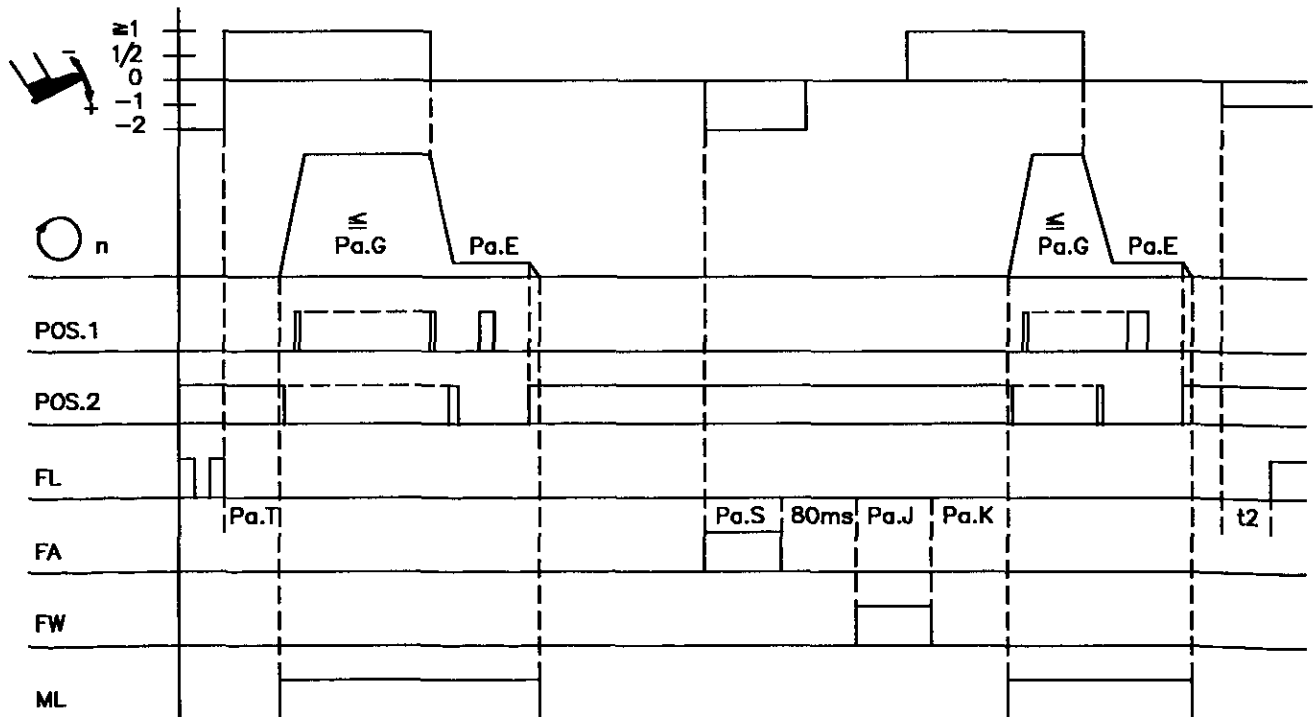

0210/KETTE1A

10.10 Trimming from Full Machine Run

Chainstitch mode 2 (Parameter Q = 6)

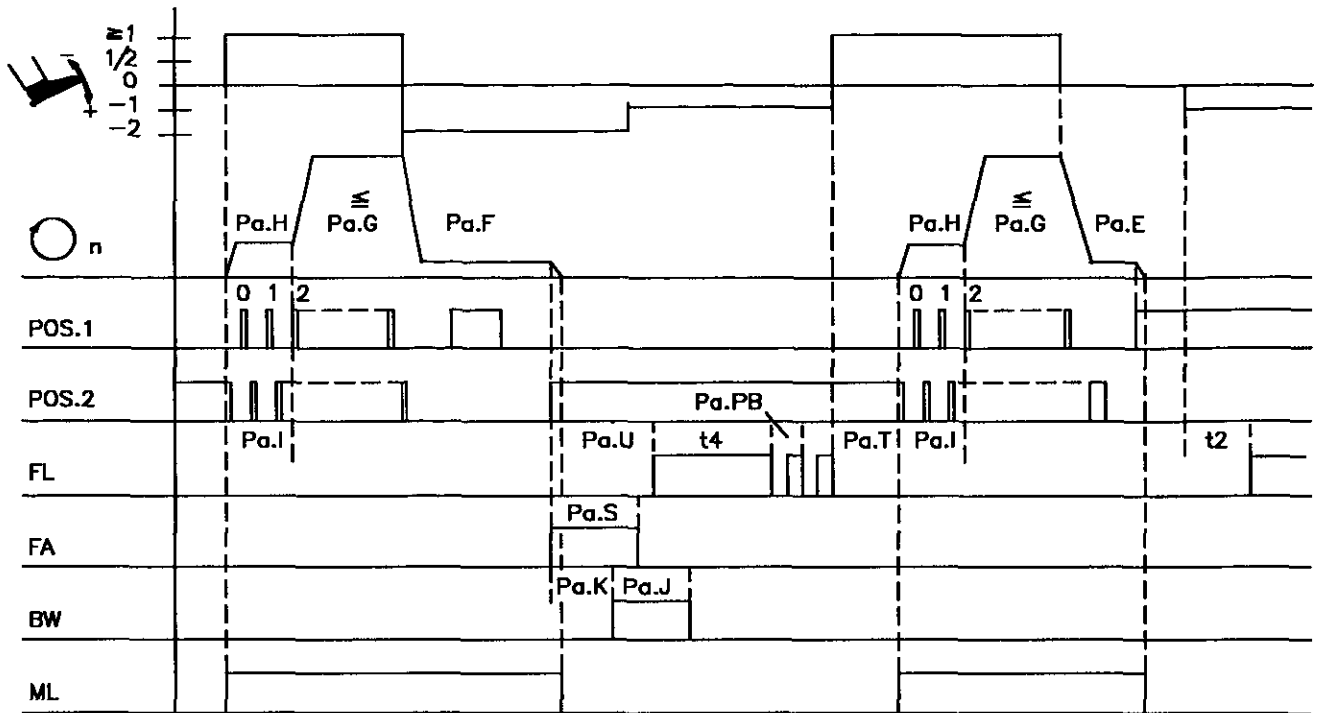

0210/KETTE2

10.11 Trimming from Intermediate Stop with Reversion

Chainstitch mode 2 (Parameter Q = 6)

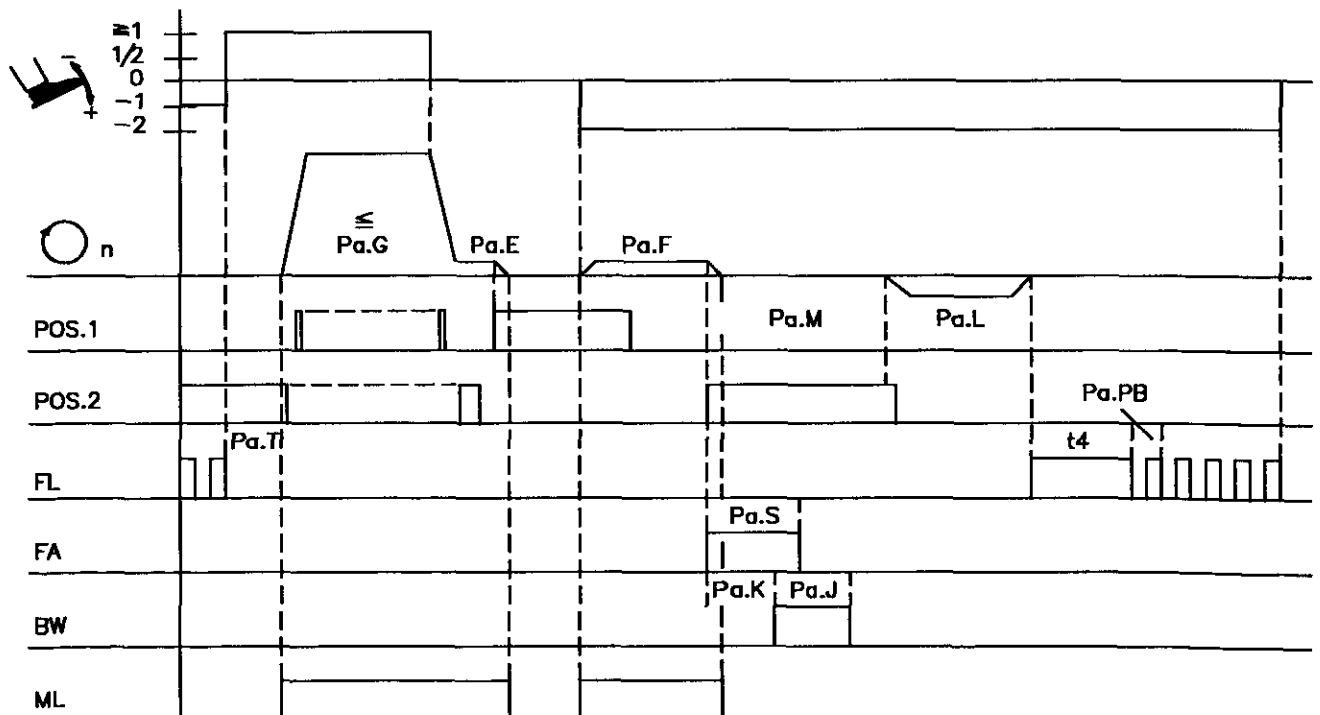

0210/KETTE2A

10.12 Thread Trimmer Off

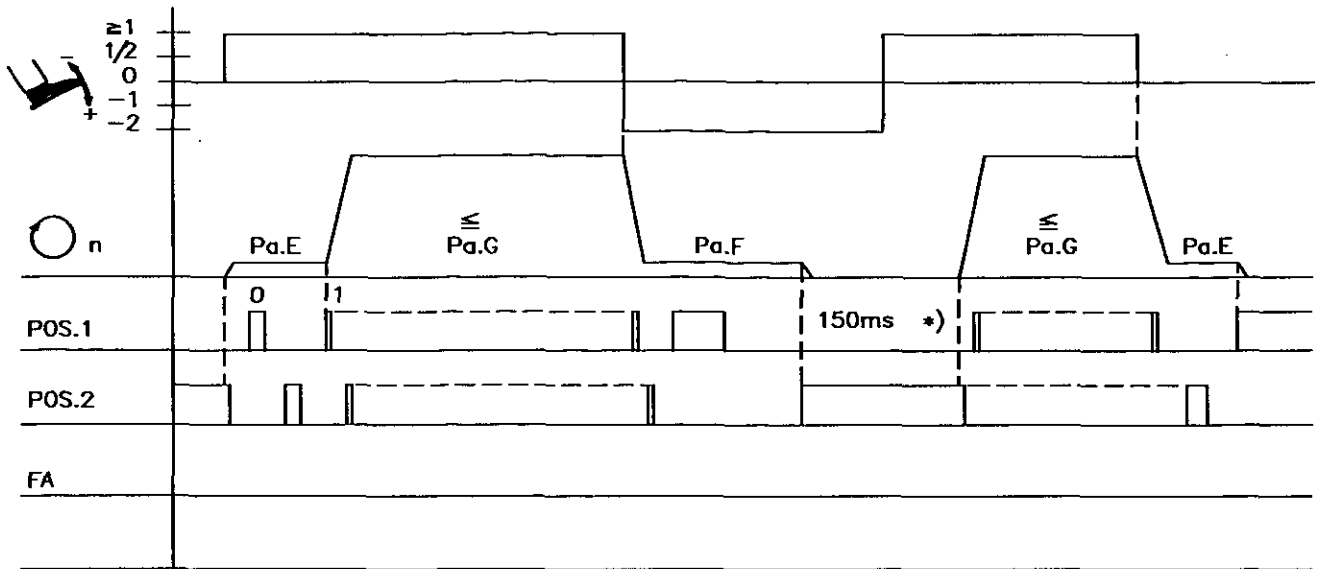

0210/STKEOV1

* If parameter Q = 6, the time is 0.

Parameter	Function	
W	Trimmer off Slow stitch after power on	(LED 5 = off) on

10.13 Blocking of Machine Run / Needle Up/Down

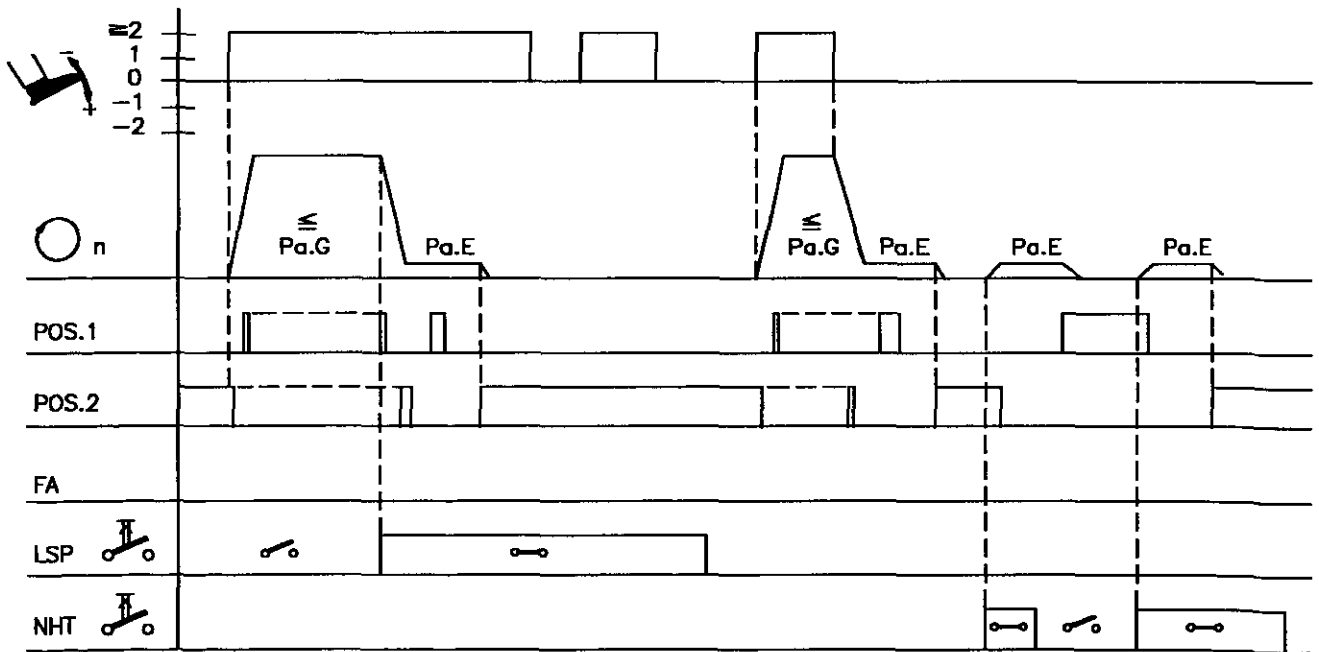

























0210/STKEOV1A

Parameter	Function	
V	Blocking of machine run as make contact (N.O.) Basic position 2	V = 00 (LED 7 = on)

Table of parameters and abbreviations see beginning of chapter

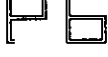
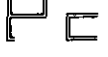
11. Parameter List

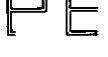
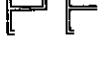
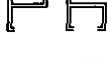
Parameter	Display	Function	Unit	Max	Min	Preset
A		Setting the reference position				
B		Setting position 1				
C		Setting position 2				
D		Setting position 1A				
E		Positioning speed, first pedal stage	x 10 rpm	39	06	15
F		Thread trimming speed	x 10 rpm	39	06	18
G		Maximum speed	x 100 rpm	99	04	30
H		Softstart speed	x 10 rpm	99	07	50
I		Number of Softstart stitches		09	00	03
J		Operating time of the thread wiper	x 100 ms	25	0.0	2.0
K		Activation delay - - of presser foot lifting after thread wiping (mode 1...5) - of the blow wiper (mode 6)	x 10 ms	99	00	08
L		Number of reversion increments	x 10 incr.	60	00	00
M		Activation delay of reversion	x 10 ms	99	00	00
N		Direction of rotation of the motor (look at motor shaft)	counterclockwise = 01 clockwise = 00	01	00	00
O		Braking power at standstill		30	00	05

Parameter	Display	Function	Unit	Max	Min	Preset
Q		Machine select Lockstitch mode 1 = 01 Lockstitch mode 2 = 02 Lockstitch mode 3 = 03 Lockstitch mode 4 = 04 Chainstitch mode 1 = 05 Chainstitch mode 2 = 06		06	01	01
S		Operating mode of chain stitch thread trimmer (mode 5, 6)	x 100 ms	25	00	1.5
T		Start delay from lifted foot	x 10 ms	60	00	08
U		Activation delay of presser foot lifting at the seam end (mode 6)	x 100 ms	25	0.0	3.2
V		Blocking of machine run - active when switch closed = 00 - active when switch opened = 01		01	00	00
W		Slow stitch after power on	off = 00 on = 01	01	00	01
PB		Pulse width for (1 = low holding power) presser foot (7 = high holding power) lift pulsing (0 = full power)		07	00	03
PC		Softstart on/off	off = 00 on = 01	01	00	00
PD		Starting edge		60	01	32
PE		Braking edge 1		60	01	10
PF		Braking edge 2		60	01	32
PH		Test function for the outputs and the position transmitter				
PI		Test function for the inputs				

12. Operating Elements and Socket Connectors

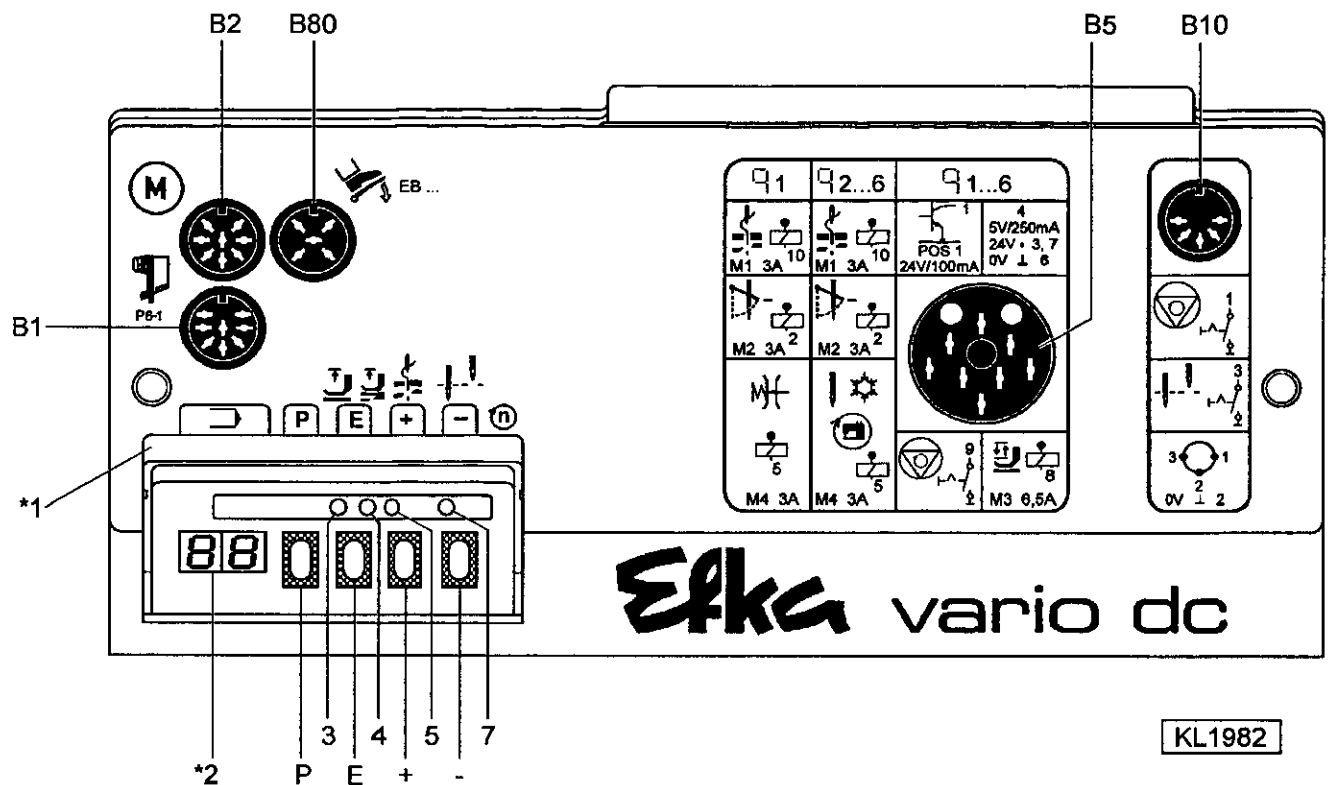

- B1 = Position transmitter
 B2 = Commutation transmitter for d.c. motor
 B5 = Solenoids and switches
 B80 = Actuator

- *1 = Type designation
 *2 = Display (2-digit seven segment display)

- Pushbutton P = Recall or exit of programming mode
 Pushbutton E = Programming mode: enter button for modifications
 Operator mode: Softstart on/off
 Pushbutton + = Programming mode: increase of the indicated value
 Operator mode: thread trimmer on/off
 Pushbutton - = Programming mode: decrease of the indicated value
 Operator mode: basic position up/down
 Operator mode (during machine run): decrease maximum speed limit
 LED 3 = Presser foot lifting in the seam (LED on = on)
 LED 4 = Presser foot lifting after the seam end (LED on = on)
 LED 5 = Thread trimmer (LED on = on)
 LED 7 = Basic position (LED on = up)

Efka

FRANKL & KIRCHNER GMBH & CO KG
SCHEFFELSTRASSE 73 - 68723 SCHWETZINGEN
TEL.: (06202)2020 - TELEFAX: (06202)202115 - TELEX: 466314

Efka

OF AMERICA INC.
3715 NORTHCREST ROAD - SUITE 10 - ATLANTA - GEORGIA 30340
PHONE: (404)457-7006 - TELEFAX: (404)458-3899 - TELEX: EFKA AMERICA 804494

Efka

ELECTRONIC MOTORS SINGAPORE PTE. LTD.
67, AYER RAJAH CRESCENT 05-03 - SINGAPORE 0513
PHONE: 7772459 or 7789836 - TELEFAX: 7771048

1(1)-050795-A(402144EN)