

# **Efka** variostop

**CONTROL**

**8B80A**

**Replaces 3A31E/6B30B/9B30A**

**INSTRUCTION MANUAL**

**WITH PARAMETER LIST**

**No. 402164**

**english**

---

**Efka**  
FRANKL & KIRCHNER  
GMBH & CO KG

**Efka**  
EFKA OF AMERICA INC.

**Efka**  
EFKA ELECTRONIC MOTORS  
SINGAPORE PTE. LTD.

---

<b>Contents</b>	<b>Page</b>
<b>1. Important Safety Instructions</b>	<b>1</b>
<b>2. Range of Applications</b>	<b>2</b>
2.1 Use in Accordance with Regulations	2
<b>3. Complete Drive Unit Consisting of</b>	<b>2</b>
3.1 Special Accessories	3
<b>4. Operating the Control without Variocontrol</b>	<b>3</b>
4.1 Access to Programming on Command Input	3
4.2 Programming the Code Number	4
4.3 Selection of the Parameters	5
4.3.1 Direct Selection	5
4.3.2 Changing Parameter Values	6
4.3.3 Selection by Using the +/- Pushbuttons	7
4.4 Switchable Functions	7
<b>5. Starting Service</b>	<b>8</b>
<b>6. Setting the Basic Functions</b>	<b>8</b>
6.1 Selection of the Type of Machine	8
6.2 Positioning Speed	8
6.3 Maximum Speed	8
6.4 Positions	9
6.5 Display of the Signal and Stop Positions	10
6.6 Braking Behavior	10
6.7 Braking Power at Standstill	10
6.8 Start Behavior	11
6.9 Speed Gate	11
<b>7. Functions</b>	<b>12</b>
7.1 First Stitches After Power On	12
7.2 Softstart	12
7.2.1 Softstart Speed	12
7.2.2 Softstart Stitches	12
7.3 Direct Input of Maximum Speed Limitation (DED)	12
7.4 Presser Foot Lifting	13
7.5 Thread Trimming	14
7.5.1 Chainstitch Thread Trimmer	14
7.5.2 Lockstitch Thread Trimmer	14
7.6 Function with Varioreset	14
7.7 Free Seam and Seam with Light Barrier	15
7.8 Light Barrier	15
7.8.1 Speed after Light Barrier Sensing	15
7.8.2 General Light Barrier Functions	15
7.8.3 Reflection Light Barrier	15
7.8.4 Light Barrier Filter for Knitted Fabrics	16
7.8.5 Functional Variations of the Light Barrier Input	16
7.9 Functional Variations of the Input on Socket B3/1	17
7.10 Actuator	17

---

<b>8. Signal Test</b>	<b>18</b>
<b>9. Error Messages</b>	<b>19</b>
<b>10. Connection Diagrams</b>	<b>20</b>
<b>11. Function Diagrams</b>	<b>24</b>
11.1 Trimming from Full Run and from Intermediate Stop (without Adapter Cord)	24
11.2 Light Barrier Sensing (without Adapter Cord)	25
11.3 Trimming from Full Run and from Intermediate Stop (with Adapter 1112555)	26
11.4 Light Barrier Sensing (with Adapter 1112555)	27
11.5 Trimming from Full Run and from Intermediate Stop (with Adapter 1112551)	28
11.6 Light Barrier Sensing (with Adapter 1112551)	29
11.7 Trimming from Full Run and from Intermediate Stop (with Adapter 1112545)	30
11.8 Light Barrier Sensing (with Adapter 1112545)	31
<b>12. Parameter List</b>	<b>32</b>
12.1 OPERATOR LEVEL	32
12.2 TECHNICIAN LEVEL	32
12.3 SUPPLIER LEVEL	34
<b>13. Operating Elements and Socket Connectors</b>	<b>37</b>

## 1. Important Safety Instructions

When using an EFKA drive and accompanying appliances (e.g. for sewing machines), basic safety precautions should always be followed, including the following:

- Read all instructions thoroughly before using this drive.
  - Drive and accompanying appliances should be mounted and put into operation by qualified personnel in accordance with the guidelines provided in the instruction manual.
- To reduce the risk of burns, fire, electric shock, or personal injury:**
- Use this drive only for its intended use as described in the instruction manual.
  - Use only attachments recommended by the manufacturer or as contained in the instruction manual.
  - Do not operate without corresponding protective devices.
  - Never operate this drive if one or more parts (e.g. cables, plugs) are damaged, if it is not working properly, if any damages can be identified or are to be suspected (e.g. after it has been dropped). Only qualified personnel are authorized to make adjustments, eliminate faults and complete repair work.
  - Never operate the drive with the air openings blocked. Keep ventilation openings of the drive free from the accumulation of lint, dust and loose cloth.
  - Never drop or insert any object into any opening.
  - Do not use drive outdoors.
  - Do not operate where aerosol (spray) products are being used or where oxygen is being administered.
  - To disconnect, turn off main switch, then remove plug from outlet.
  - Do not unplug by pulling on cord. To unplug, grasp the plug, not the cord.
  - Keep fingers away from all moving machine parts. Special care is required e.g. around the sewing machine needle and the V-belt.
  - Before mounting and adjusting accompanying appliances, i.e. position transmitter, reversing device, light barrier, etc., disconnect drive from mains (turn off main switch, remove mains plug from outlet [DIN VDE 0113 part 301; EN 60204-3-1; IEC 204-3-1]).
  - Always switch off (0) machine and remove plug from outlet, when removing covers, mounting accompanying appliances, position transmitter especially, light barrier, etc., or any other devices mentioned in the instruction manual.
  - Only qualified personnel are authorized to work on the electrical components.
- Work on high voltage circuit areas is forbidden, except as stated in the respective regulations, e.g. DIN VDE 0105 part 1.
  - Only specially trained personnel are authorized to complete repair work.
  - Cables to be wired must be protected against expectable strain and fastened adequately.
  - Cables near moving machine parts (e.g. V-belts) must be wired at a minimum distance of 25 mm (see DIN VDE 0113 part 301; EN 60204-3-1; IEC 204-3-1).
  - For safety it is preferred to wire the cables separately from each other.
  - Before connecting the mains line make sure that the mains voltage corresponds to the specifications on the motor rating plate and on the nameplate of the power pack.
  - Connect this drive to a properly grounded outlet only. See Grounding Instructions.
  - Electric accompanying appliances and accessories must only be connected to safety low voltage.
  - EFKA DC drives are protected according to overvoltage class 2 (DIN VDE 0160 § 5.3.1).
  - Observe all safety guidelines before undertaking conversions or modifications.
  - For repair and maintenance use only original replacement parts.



Warnings in the instruction manual which point out particular risks of personal injury or risk to the machine are marked with this symbol wherever applicable.



This symbol is a warning on the control and in the instruction manual. It indicates hazardous voltage.

**CAUTION** - In the case of failure this area can be current-carrying even after having turned the power off (non discharged capacitors).

- The drive is not an independently operating unit, but is designed to be incorporated into other machinery. It must not be put into service until the machinery into which it is to be incorporated has been declared in conformity with the provisions of the EC Directive.

**Save these instructions for future reference.**

## 2. Range of Applications

The drive is suitable for industrial sewing machines in general,

especially for the following sewing machines:

Brand	Series
SINGER	591D 200B 591D 300B 211U, 212U
ONDAL	Machine for binding of a harness

### 2.1 Use in Accordance with Regulations

The drive is not an independently operating machine, but is designed to be incorporated into other machinery. It must not be put into service until the machinery into which it is to be incorporated has been declared in conformity with the provisions of the EC Directive (Appendix II, paragraph B of the Directive 89/392/EEC and supplement 91/368/EEC).

The drive has been developed and manufactured in accordance with the respective EC standards:

EN 60204-3-1:1990      Electric equipment of industrial machines:  
special requirements for industrial sewing machines,  
sewing units and sewing systems.

The drive can only be operated:

- on thread processing machines and on machines for binding of a harness
- in dry areas

## 3. Complete Drive Unit Consisting of

1	Induction motor with electromagnetic clutch	V...
1	Control	8B80A
	- Power pack	N30
1	Position transmitter	P5-2
1	Set of standard accessories consisting of:	B10 belt guard, complete (for pulleys up to 132 mm $\phi$ ) set of hardware motor foot bracket 1 and 2, short documentation
1	Set of accessories consisting of	Z3
1	Pulley	pitman rod, complete

### 3.1 Special Accessories

Adapter cord for Singer (replacing 6B30B)	- part no. 1112555
Adapter cord for Ondal (replacing 9B30A)	- part no. 1112551
Adapter cord for general application (replacing 3A31E)	- part no. 1112545
Belt guard (for pulleys up to 180 mm $\phi$ )	- part no. 7960012
Reflection light barrier module Variolux LSM001	- part no. 6100028
Extension cable for external actuator, approx. 750 mm long, complete with plug and socket connector	- part no. 1111845
Extension cable for external actuator, approx. 1500 mm long, complete with plug and socket connector	- part no. 1111787
5-pin plug with slide index for the connection of another external actuator	- part no. 0501278
External actuator type EB301 with approx. 250 mm connecting cable and 5-pin plug with slide index	- part no. 41.0011
External actuator type EB302 (softer spring) approx. 250 mm connecting cable and 5-pin plug with slide index	- part no. 41.0012
Foot control type FB302 for standing operation with approx. 1400 mm connecting cable and plug	- part no. 4160018
Potential equalization cord 700 mm long, LIY 2.5 mm <sup>2</sup> , grey, with forked cable brackets on both sides	- part no. 1100313
Extension cable for position transmitter P5-..., approx. 1100 mm long, complete with plug and socket connector	- part no. 1111584
Extension cable for position transmitter P5-..., approx. 315 mm long, complete with plug and socket connector	- part no. 1111229
Knee switch type KN3 (pushbutton) with cord of approx. 950 mm length without plug	- part no. 58.0013
Sewing light transformer	- please indicate line voltage and sewing light voltage (6.3V or 12V)
10-pin plug	- part no. 0500357

## 4. Operating the Control without Variocontrol

### 4.1 Access to Programming on Command Input

In order to prevent the unintentional modification of preset functions the input commands are distributed at various levels.

The following persons have access:

- the supplier to the highest and all subordinate levels by a code number
- the technician to the next lower and all subordinate levels by a code number
- the operator to the lowest level without code number

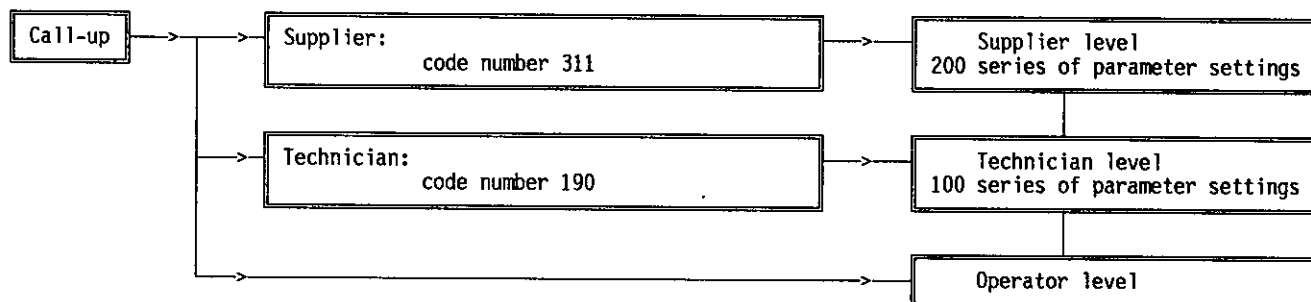

### 4.2 Programming the Code Number

1. Press pushbutton P and turn power on

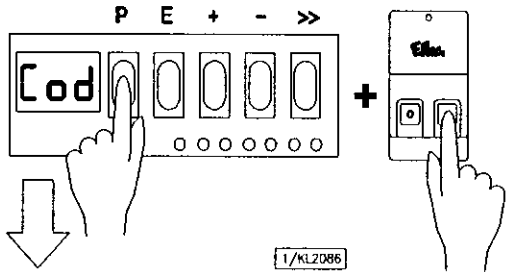

5. Press pushbutton + and/or - to select the second digit

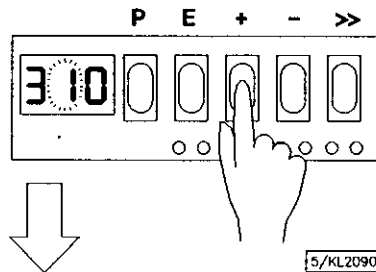

2. Press pushbutton >> (first digit blinks)

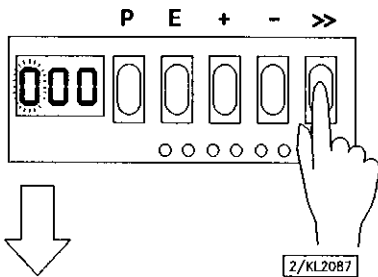

6. Press pushbutton >> (third digit blinks)

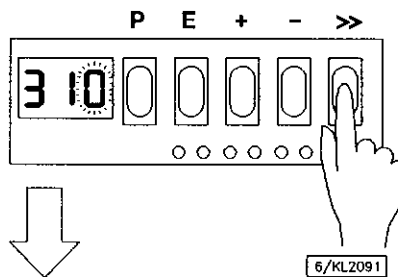

3. Press pushbutton + and/or - to select the first digit  
 Technician level ==> Code no. 190  
 Supplier level ==> Code no. 311

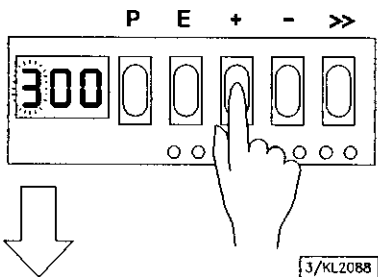

7. Press pushbutton + and/or - to select the third digit

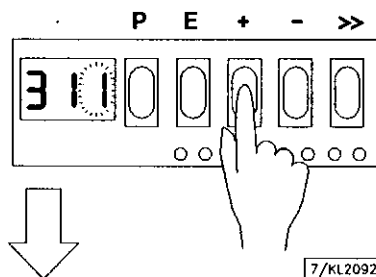

4. Press pushbutton >> (second digit blinks)

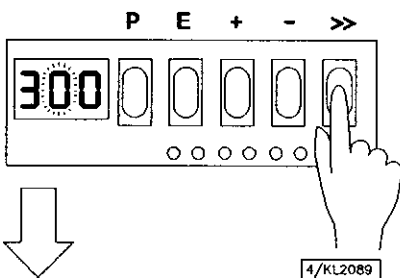

8. Press pushbutton E; the parameter number is displayed, which is indicated by points between the digits.

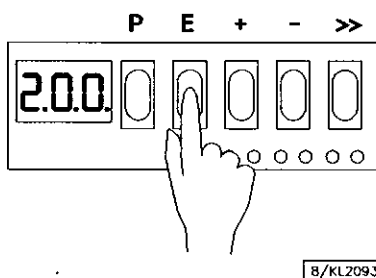

## 4.3 Selection of the Parameters

### 4.3.1 Direct Selection

1. After inputting the code number on the programming level

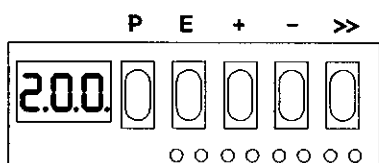

9/KL2094

2. Press pushbutton >> (first digit blinks)

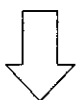
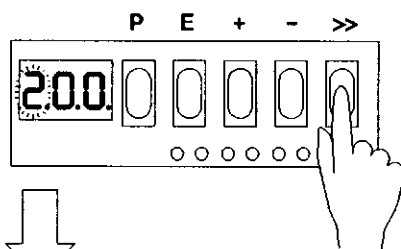

13/KL2098

3. Press pushbutton + and/or - to select the first digit

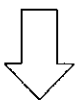
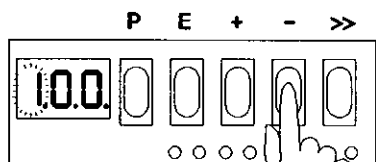

14/KL2099

4. Press pushbutton >> (second digit blinks)

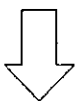
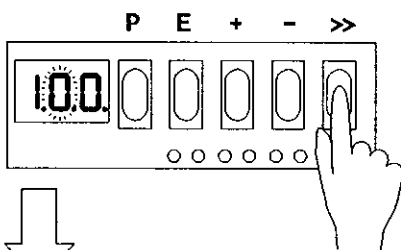

15/KL2100

5. Press pushbutton + and/or - to select the second digit

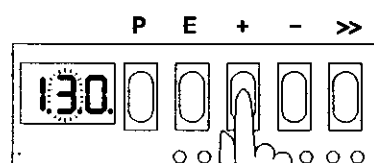

16/KL2101

6. Press pushbutton >> (third digit blinks)

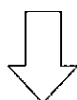
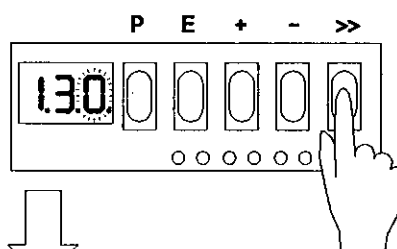

17/KL2102

7. Press pushbutton + and/or - to select the third digit

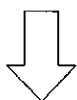
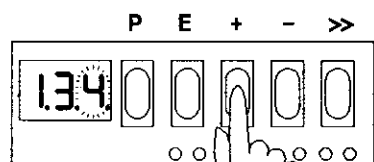

18/KL2103

8. Press pushbutton E; parameter value is displayed. There are no points between the digits.

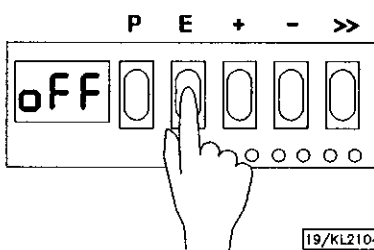

19/KL2104



### 4.3.2 Changing Parameter Values

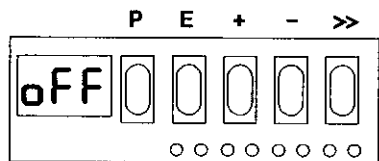

Display after selecting the parameter value



20/KL2105

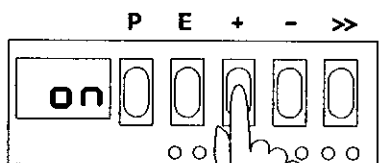

Change parameter value by pressing pushbutton + and/or -



21/KL2106

#### Possibility n° 1:

Press pushbutton E. The next parameter number is displayed.

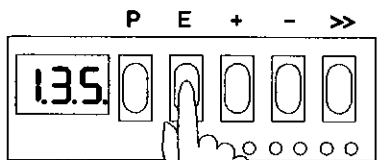

#### Possibility n° 2:

Press pushbutton P. The same parameter number is displayed.

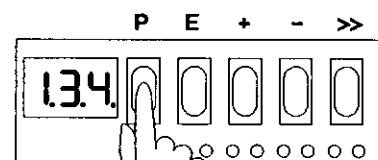

22/KL2107



23/KL2108

Press pushbutton P. Exit programming. The changed parameter values will only be saved by starting to sew again!

Press pushbutton P. Exit programming. The changed parameter values will only be saved by starting to sew again!

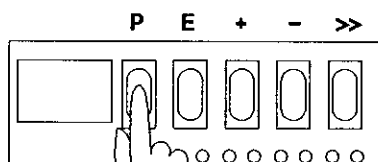

25/KL2111

25/KL2111

### 4.3.3 Selection by Using the +/- Pushbuttons

1. After inputting the code number on the programming level

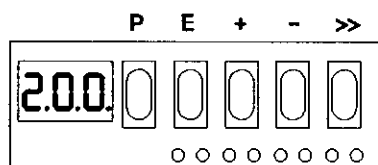

9/KL2094

3. Select previous parameter by pressing the - pushbutton

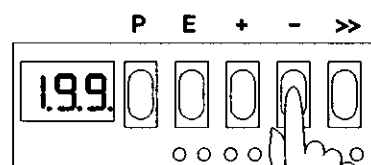

11/KL2096

2. Select the next parameter by pressing the + pushbutton

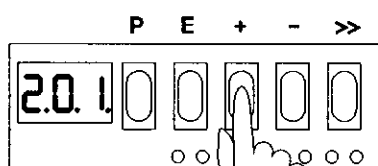

10/KL2095

4. After pressing pushbutton E, the parameter value is displayed

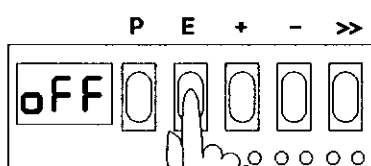

12/KL2097

### 4.4 Switchable Functions

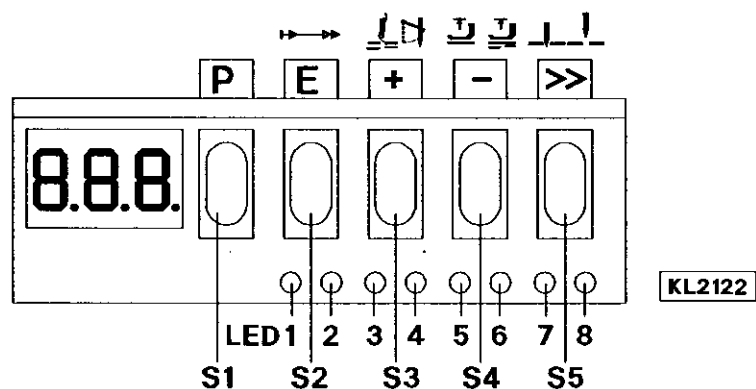

Switchable functions can be changed by pressing a pushbutton. The switching state is indicated by light emitting diodes (LED). See above illustration!

**Table:** Allocation of functions for pushbuttons and LEDs

Function	Pushbutton	LED number	
Softstart On	E	1 = on	2 = off
Softstart Off	E	1 = off	2 = off
Thread trimmer On	+	3 = on	4 = off
Thread trimmer and thread wiper On	+	3 = on	4 = on
Thread trimmer and thread wiper Off	+	3 = off	4 = off
Presser foot lifting at stop in the seam (automatic)	-	5 = on	6 = off
Presser foot lifting at the seam end (automatic)	-	5 = off	6 = on
Presser foot lifting at stop in the seam and at the seam end (automatic)	-	5 = on	6 = on
Basic position down (position 1)	>>	7 = on	8 = off
Basic position up (position 2)	>>	7 = off	8 = on

## 5. Starting Service

The machine is ready for operation immediately after:

- mounting the drive and the position transmitter
- adapting the control to the sewing machine
- setting the needle positions on the position transmitter

## 6. Setting the Basic Functions

### 6.1 Selection of the Type of Machine

Selection of the type of machine	Ident. number
without adapter cord (chainstitch function)	
with adapter cord for Singer cl. 591D200B, 591D300B, 211U, 212U (replacing 6B30B)	1112555
with adapter cord for Ondal machine for binding of a harness (replacing 9B30A)	1112551
with adapter cord for general application (replacing 3A31E)	1112545

Depending on the adapter cord various inputs and outputs are selected according to the following table.

Socket	Without Adapter	Adapter No. 1112555	Adapter No. 1112551	Adapter No. 1112545
<b>Outputs:</b> B3/3-5 B3/7-8 B3/7-10	Chainstitch trimmer Presser foot lifting Chainstitch trimmer	free Thread wiper Thread trimmer	free free Motor running	free Presser foot lifting Varioreset
<b>Inputs:</b> B3/1-4	Needle up/down	Needle up/down	Blocking of machine run	Speed limitation

See also chapters "Connection Diagram" and "Function Diagrams" !

### 6.2 Positioning Speed

Functions	Parameter
Positioning speed	110

The positioning speed can be set by parameter 110 on the control within a range of 70...390 RPM.  
When programming 4-digit parameter values, the 3-digit values displayed must be multiplied by 10.

### 6.3 Maximum Speed

Functions	Parameter
Maximum Speed	111

When programming 4-digit parameter values, the 3-digit values displayed must be multiplied by 10.

**Note:**

For the maximum speed of the sewing machine see instruction manual of the sewing machine manufacturer.

**6.4 Positions**

Before setting the position transmitter ensure that the direction of rotation of the motor shaft is correctly set !

**Attention!**

If the motor is mounted differently, e.g at a different angle or with gear, make sure that the parameter value is assigned correctly to the direction of rotation.

**Attention!**

Turn power off before adjusting the positioning discs.

**Attention!**

Be very careful when adjusting the positioning discs.

**Risk of injury.**

Please ensure that positioning discs and generator disc (inner disc) are not damaged.

The positions are set as follows:

- Remove position transmitter cover after loosening the screw.
- Select basic position **needle down** (LED 7 on the control lights up) by pushbutton S5.
- Adjust central disc for position 1 in the desired direction.
- Push pedal briefly forward.
- Check stop position.
- Push pedal backward (trimming).
- Select basic position **needle up** (LED 8 on the control lights up) by pushbutton S5.
- Adjust outer disc for position 2 in the desired direction.
- Push pedal briefly forward.
- Check stop position.
- Repeat procedure if necessary.
- Select the desired basic position by pushbutton S5.
- Put cover on again and tighten screw.

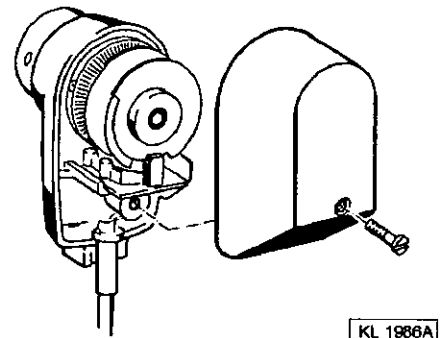
**Note:**

For functional sequences that are controlled by the slot width, set slot width if necessary according to the above. The desired functional sequence is to be activated in order to check the setting. The opening angle of position transmitters with adjustable slot width must not be below 20°.

**Note:**

To ensure a correct trimming operation, the positions 1 and 2 must not overlap.

### 6.5 Display of the Signal and Stop Positions

Function	Parameter
Display of positions 1 and 2	172

The setting of the positions can easily be tested by parameter 172.

- Address parameter F-172
- "PoS" appears on the display
- Turn handwheel corresponding to the direction of rotation of the motor

#### Control display

- LED 7 on corresponds to position 1
- LED 7 turns off corresponds to position 1A
- LED 8 on corresponds to position 2
- LED 8 turns off corresponds to position 2A

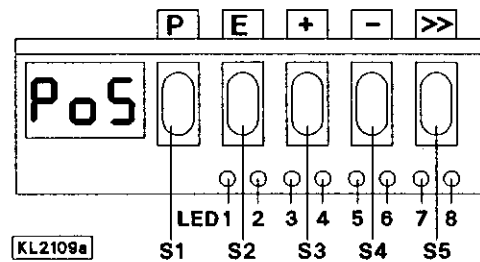

### 6.6 Braking Behavior

Function	Parameter
Braking effect with speeds ≤ 800 RPM	207
Braking effect when modifying the preset value ≥ 800 RPM	208

The braking effect of the drive can be set.

The following applies to all setting values:  
The higher the value the more aggressive the braking reaction!

### 6.7 Braking Power at Standstill

Function	Parameter
Braking power at standstill	153

This function prevents unintentional "wandering" of the needle at standstill.  
The effect can be tested by turning the handwheel.

- The braking power works at standstill
  - at stop in the seam
  - after trimming
- The effect can be set
- The higher the set value, the higher the braking power
- It works immediately after power on

## 6.8 Start Behavior

Function	Parameter
Starting edge	220

The drive accelerating dynamics can be adapted to the characteristic of the sewing machine (light, heavy).

- High setting value = high acceleration

With a high starting edge setting and, in addition, possibly high braking parameter values on a light machine, the behavior may appear coarse. In this case, one should try to optimize the settings.

## 6.9 Speed Gate

Function	Parameter
Speed gate	221
Speed gate damping period	222

The speed gate setting and the setting of the speed gate damping period are important for exact positioning. The switching point of the speed gate is determined by positioning speed + value in parameter 221; example:  $n1 = 180$  RPM + value 100 = 280.

## 7. Functions

### 7.1 First Stitches After Power On

Function	Parameter
Set stitches at npos after POWER ON	231

For the protection of the sewing machine, the first stitches (1...3) in parameter 231 after power on will be performed at positioning speed, independently of the pedal position and the function Softstart. If the setting is at "0" this function is switched off.

### 7.2 Softstart

Function	Pushbutton on the control
Softstart on/off	LED1 On/Off
	Pushbutton S2

Function:

- after power on
- at the beginning of a new seam
- speed limited (n6), pedal controlled
- lower speed predominates (e.g. positioning speed)
- stitch counting synchronized to position 1
- interruption with pedal in position 0 (neutral)
- cessation by full heelback (position -2)

#### 7.2.1 Softstart Speed

Function	Parameter
Softstart speed	115

When programming 4-digit parameter values, the 3-digit values displayed must be multiplied by 10.

#### 7.2.2 Softstart Stitches

Function	Parameter
Softstart stitches	100

If the function "slow stitch after power on" has been selected by parameter 231, the first stitch after power on will be performed at positioning speed, independently of the Softstart setting.

### 7.3 Direct Input of Maximum Speed Limitation (DED)

The maximum speed of the machine can be limited to the specific level according to the application directly by using pushbuttons +/- on the Variocontrol during machine run or during intermediate stop. This function is blocked at the start of the seam and/or after trimming. The actual value is shown on the display and must be multiplied by 10.

## 7.4 Presser Foot Lifting

Function		Pushbutton on the control
Automatic in the seam	LED 5 lights up	Pushbutton S4
Automatic after thread trimming	LED 6 lights up	Pushbutton S4

Function		Parameter
Activation delay when pedal is in position -1, half heelback	(t2)	201
Start delay from lifted foot	(t3)	202
Time of full power	(t4)	203
Holding current of presser foot lifting	(t5)	204
Delay after Varioreset until presser foot lifting	(t7)	206
Delay after chainstitch trimmer	(t7)	286

### Presser foot is lifted:

- in the seam
  - by heeling the pedal back (position -1)
  - or automatically (by pushbutton S4 on the control, LED 5 lights up)
  - by external actuator, if parameter 240 and/or 242 = 12
- after thread trimming
  - by heeling the pedal back (position -1 or -2)
  - or automatically (by pushbutton S4 on the control, LED 6 lights up)
  - by external actuator, if parameter 240 and/or 242 = 12
  - by light barrier or by stitch counting, automatically

Unintentional foot lifting before thread trimming, when changing from pedal position 0 (neutral) to position -2, can be prevented by setting an activation delay (t2) by parameter 201.

### Holding power of the lifted foot:

The presser foot is lifted by full power. Then the solenoid is switched to partial power in order to reduce the load for the control and for the connected solenoid.

The duration of full power is set by parameter 203, the holding power at partial power by parameter 204.



### Caution!

If the holding power is set too high the solenoid and the control may be permanently damaged. Please observe the allowed operating time of the solenoid and set the appropriate value according to the table below.

Stage	Operating time	Effect
1	12.5 %	low holding power
2	25 %	
3	37.5 %	
4	50 %	
5	62.5 %	
6	75 %	
7	87.5 %	high holding power

### Foot lowers:

- from manual foot lifting, when pedal is in position 0 (neutral) (position  $\geq 0$ )
- from automatic foot lifting, when pedal heeled forward (position  $> 0$ )

When pushing the pedal forward from lifted presser foot, the start delay (t3) that can be set by parameter 202 becomes effective.



## 7.5 Thread Trimming

Function	Pushbutton on the control
Thread trimming On/Off	Pushbutton S3

### 7.5.1 Chainstitch Thread Trimmer

#### When operating the control without adapter cord

- The thread is trimmed in position 2 at machine standstill.
- When thread trimming is switched off, the drive stops in position 2 at the seam end.
- The activation and delay times of the thread trimmers (M1 and M2) can be set.

Function		Parameter
Delay time for M1 (needle thread trimmer)	kd1	280
Activation time for M1 (needle thread trimmer)	kt1	281
Delay time for M2 (bobbin thread trimmer)	kd2	282
Activation time for M2 (bobbin thread trimmer)	kt2	283
Delay time until presser foot On	t7	286

For the thread trimming function see chapter "Function Diagrams".

### 7.5.2 Lockstitch Thread Trimmer

#### When operating the control with adapter cord 1112555

- The thread trimming is performed at positioning speed.
- When thread trimming is switched off, the drive stops in position 2 at the seam end.
- The thread wiper can be switched on together with the thread trimmer.
- The thread wiper time and the start delay after thread wiper end can be set.

Function		Parameter
Thread wiper time	(t6)	205

## 7.6 Function with Varioreset

#### When operating the control with adapter cord 1112545

Function		Parameter
Activation time for Varioreset	(t6)	205
Delay after Varioreset until presser foot lifting	(t7)	206

The Varioreset signal is emitted after the drive is at standstill. See chapter "Function Diagrams".

## 7.7 Free Seam and Seam with Light Barrier

Function	Parameter
Positioning speed (n1)	110
Upper limit of the maximum speed (n2)	111

The speed in the free seam and in the seam with light barrier ranges from positioning speed (n1) to maximum speed (n2).

## 7.8 Light Barrier

### 7.8.1 Speed after Light Barrier Sensing

Function	Parameter
Speed after light barrier sensing (n5)	114

When programming 4-digit parameter values, the 3-digit values displayed must be multiplied by 10.

### 7.8.2 General Light Barrier Functions

Function	Parameter
Light barrier compensating stitches	004
Sewing start blocked with light barrier uncovered	132

- After sensing the seam end, counting of the compensating stitches at light barrier speed is performed.
- Interruption with pedal in position -0.
- Blocking of machine start, when light barrier is uncovered, can be programmed by parameter 132.

### 7.8.3 Reflection Light Barrier

Function	Parameter
Light barrier On/Off	009

#### Adjustments

##### Sensitivity:

Depending on the distance of the light barrier to the reflection area, adjust sensitivity to a minimum. (Turn potentiometer as far as possible to the left).

- LSM001 - Potentiometer directly on the light barrier module

##### Mechanical Adjustment:

- LSM001 - The orientation is facilitated through a visible light spot on the reflection area.

### 7.8.4 Light Barrier Filter for Knitted Fabrics

Function	Parameter
Number of stitches of the light barrier filter	005

The filter prevents premature triggering of the light barrier function, when sewing knitted fabrics.

- The filter is switched on and active if parameter 005 = > 0 stitches
- By changing the number of filter stitches the mesh will be adapted

### 7.8.5 Functional Variations of the Light Barrier Input

Function	Parameter
Selection of the input function on socket B18/5	242

If the light barrier function is not used, a different function can be selected for the input on socket B18/5, and a pushbutton can be connected.

The following input functions are possible by parameter 242:

- 242 = 0      Light barrier function**  
The input is prepared for a light barrier function.
- 242 = 1      Needle up/down**  
When pressing the pushbutton the drive runs from position 1 to position 2 and/or from position 2 to position 1. If the drive is outside of the stop position it runs to the next position possible.
- 242 = 2      Needle up**  
When pressing the pushbutton the drive runs from position 1 to position 2.
- 242 = 3      Single stitch (basting stitch)**  
When pressing the pushbutton the drive performs one rotation from position 1 to position 1. If the drive is in position 2, it runs to position 1 when pressing the pushbutton and from position 1 to position 1 each time when pressing the pushbutton again.
- 242 = 4      Full stitch**  
When pressing the pushbutton the drive performs one entire rotation depending upon the stop position. If the drive is outside of the positions it runs to the preselected basic position.
- 242 = 5      Needle to position 2**  
If the drive is outside of position 2 it runs to position 2 when pressing the pushbutton.
- 242 = 6      Blocking of machine run effective with open contact**  
When opening the switch the drive stops in the preselected basic position.
- 242 = 7      Blocking of machine run effective with closed contact**  
When closing the switch the drive stops in the preselected basic position.
- 242 = 8      Blocking of machine run effective with open contact (unpositioned)**  
When opening the switch the drive stops immediately unpositioned
- 242 = 9      Blocking of machine run effective with closed contact (unpositioned)**  
When closing the switch the drive stops immediately unpositioned
- 242 = 10      Run at automatic speed (n10)**  
When pressing the pushbutton the drive runs at automatic speed. The pedal is not used.
- 242 = 11      Run at limited speed (n10)**  
When pressing the pushbutton the drive runs at limited speed. The pedal must be pushed forward.
- 242 = 12      Presser foot lifting with pedal in position 0 (neutral)**

### 7.9 Functional Variations of the Input on Socket B3/1

Function	Parameter
Selection of the input function on socket B3/1	240

If the preselected function on the input of socket B3/1 is not used, a different function can be selected by parameter 240.

The following input functions are possible:

- 240 = 0      **Input function blocked**
- 240 = 1...12      **All other input functions are identical, as described for parameter 242**

### 7.10 Actuator

With the help of the actuator connected with the pedal the commands for the sewing operation are inputted. Instead of the built-in actuator another external actuator can be connected to socket B80.

**Table: Coding of the pedal steps**

Pedal step	D	C	B	A
-2	H	H	L	L
-1	H	H	H	L
0	H	H	H	H
½	H	H	L	H
1	H	L	L	H
2	H	L	L	L
3	H	L	H	L
4	H	L	H	H
5	L	L	H	H
6	L	L	H	L
7	L	L	L	L
8	L	L	L	H
9	L	H	L	H
10	L	H	L	L
11	L	H	H	L
12	L	H	H	H

- Full heelback (e.g. initiating the seam end)
- Slight heelback (e.g. presser foot lifting)
- Pedal in position 0 (neutral)
- Pedal slightly forward (e.g. presser foot lowering)
- Speed stage 1 (n1)
- 
- ...
- ...
- ...
- ...
- ...
- Speed stage 12 (n2)
- (Pedal fully forward)

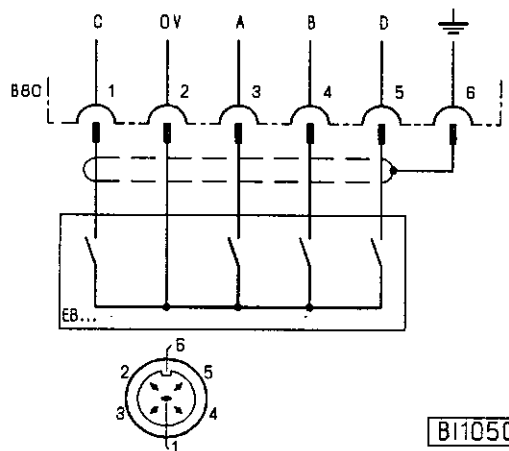

B11050

EB... - Actuator

Function	Parameter
Speed stage graduation	119

The characteristic curves of the pedal (speed change from stage to stage) can be adjusted by this parameter.

**Possible characteristic curves:**

- linear
- progressive
- highly progressive

## 8. Signal Test

Functions	Parameter
Test of inputs and outputs	173

Function test of the external inputs and the transistor power outputs with the actuators connected to them (e.g. solenoids and solenoid valves).

### Output test:

- Address parameter 173
- Select the desired output by the +/- pushbuttons
- Actuate the selected output by pushbutton > >

Pushbutton	Output
OFF/ON	Input test
o01	Output M1/motor running/thread trimmer/Varioreset
o02	Output M2
o03	free
o04	free
o05	Presser foot lifting/thread wiper

### Input test:

- Press the (-) pushbutton several times until "OFF" or "ON" appears on the control display.
- Actuation of the external switches or pushbuttons will be indicated by alternating the switching state (ON/OFF) on the display.
- Several switches must not be closed at the same time.

## 9. Error Messages

### General Information

Display	Signification
Info A1	Pedal not in neutral position, when switching the machine on
Info A2	Blocking of machine run (safety switch)

### Programming of Functions and Values (Parameters)

Display	Signification
Info F1	Wrong code number or parameter number input

### Serious Situation

Display	Signification
Info E1	Position transmitter not connected or defective
Info E2	Line voltage too low, or time between power off and power on too short
Info E3	Machine locks, or does not reach the desired speed
Info E4	Control disturbed by deficient grounding or loose contact

### Hardware Disturbance

Display	Signification
Info H2	Processor disturbed

### 10. Connection Diagrams

Control operation without adapter cord (chainstitch trimmer)

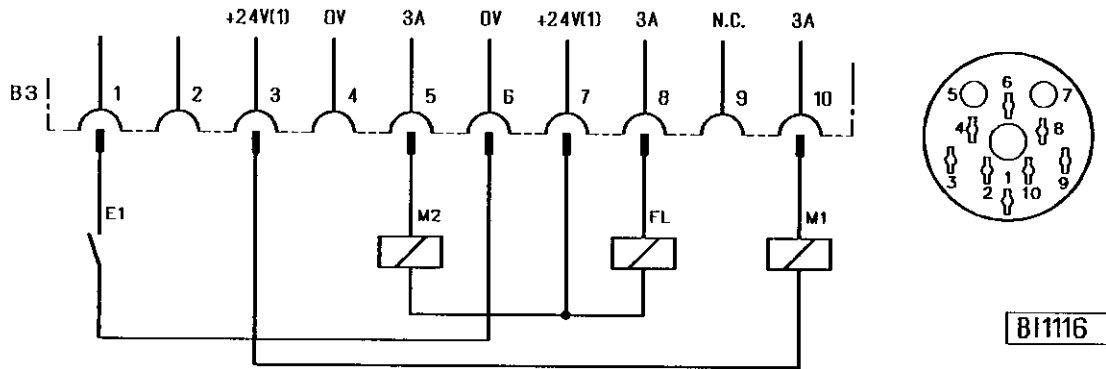

B1116



**Attention!**  
 When connecting the outputs, ensure that a total power of 96VA constant load will not be exceeded!

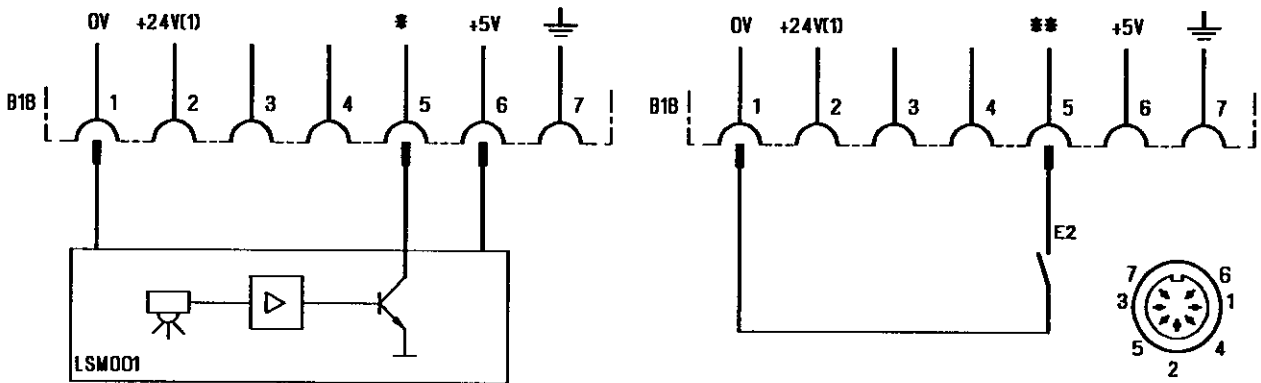

B1115

- M1 - Chainstitch thread trimmer (needle thread)
- M2 - Chainstitch thread trimmer (bobbin thread)
- FL - Presser foot lifting
  
- E1 - Parameter 240 = 0 => Input function is switched off  
 - Parameter 240 = 1...12 => Various input functions are possible on socket B3/1  
**Factory setting: Parameter 242 = 1 (needle up/down)**
  
- \* - Parameter 242 = 0 => Light barrier function is selected (identified when switched to 0V)
- \*\* - Parameter 242 = 1...12 => Various input functions are possible on socket B18/5
  
- LSM001 - Reflection light barrier module

1) Nominal voltage 24V, no-load voltage max. 36V

## Control operation with adapter cord 1112555 (replacing 6B30B)

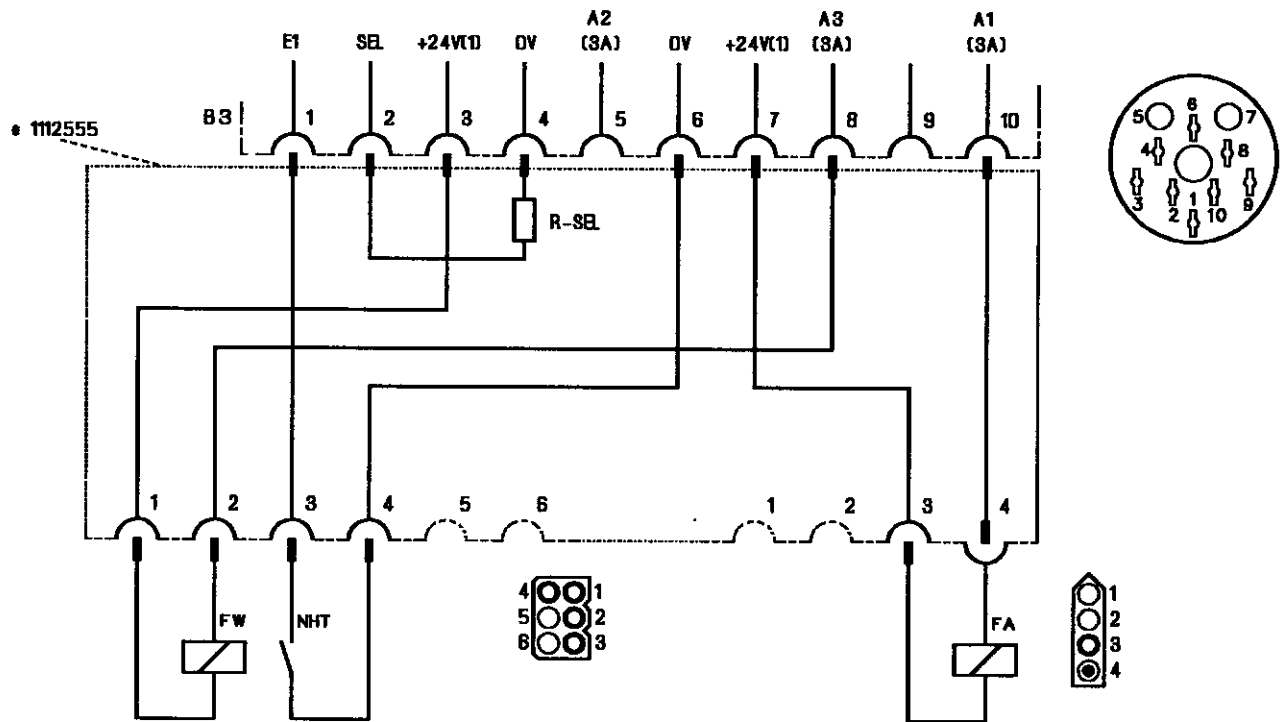

B11113

**Attention!**

When connecting the outputs, ensure that a total power of 96VA constant load will not be exceeded !

- |          |   |
|----------|---|
| FA       | - Thread trimmer  |
| FW       | - Thread wiper  |
| R-SEL    | - Select resistance 22K   |
| NHT (E1) | - Parameter 240 = 0 => Input function is switched off                           |
|          | - Parameter 240 = 1...12 => Various input functions are possible on socket B3/1 |
|          | <b>Factory setting: Parameter 242 = 1 (needle up/down)</b>                      |

1) Nominal voltage 24V, no-load voltage max. 36V



Control operation with adapter cord 1112551 (replacing 9B30A)

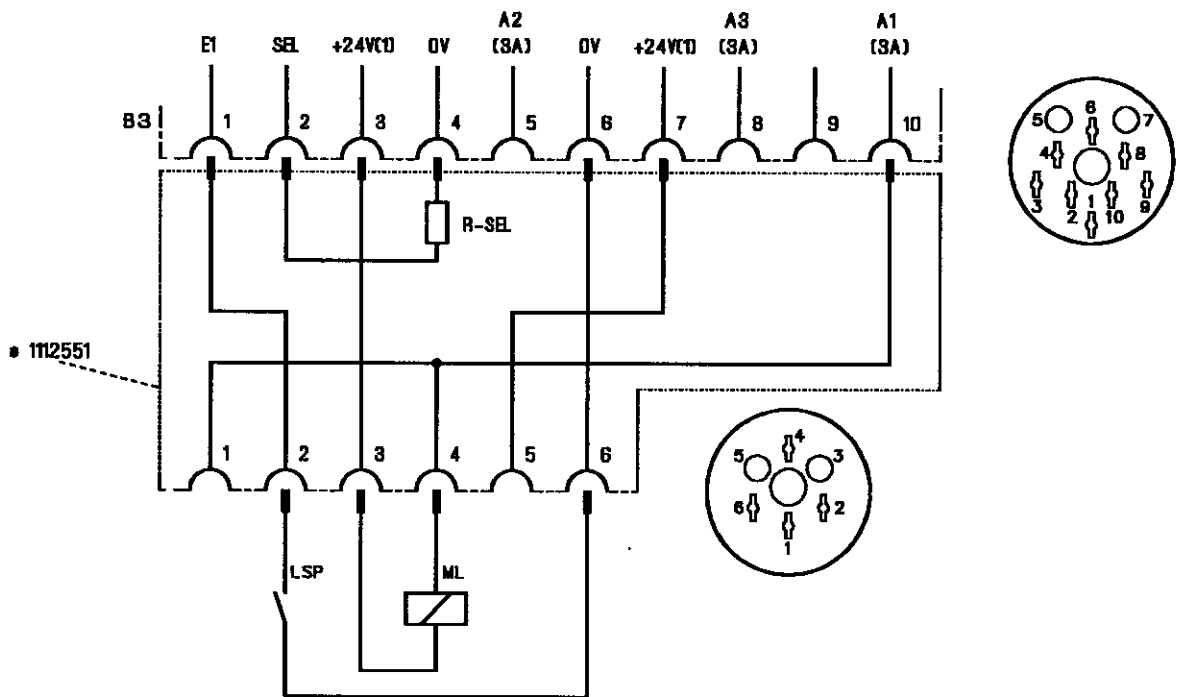

BI1111



**Attention!**

When connecting the outputs, ensure that a total power of 96VA constant load will not be exceeded !

- ML - Motor running
  - R-SEL - Select resistance 10K
  - LSP (E1) - Parameter 240 = 0 => Input function is switched off  
 - Parameter 240 = 1...12 => Various input functions are possible on socket B3/1
- Factory setting: Parameter 240 = 6 (blocking of machine run effective with break contact [N.C.]**

1) Nominal voltage 24V, no-load voltage max. 36V

## Control operation with adapter cord 1112545 (replacing 3A31E)

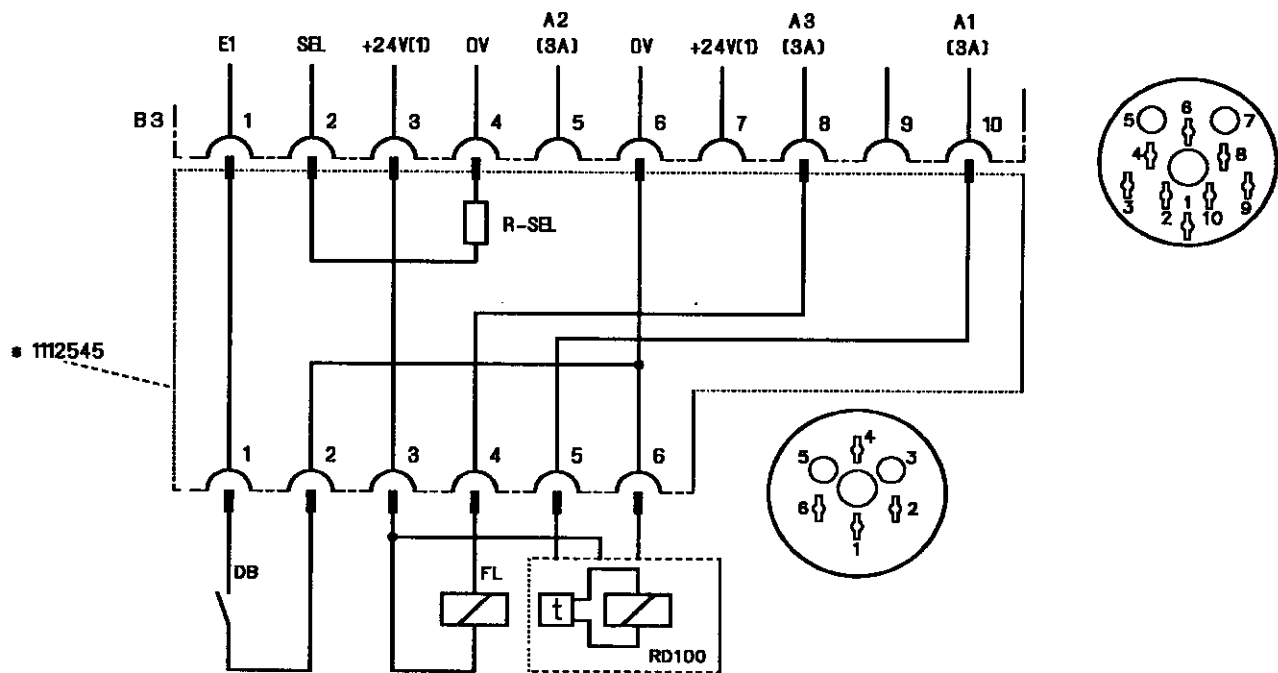

BI1112

**Attention!**

When connecting the outputs, ensure that a total power of 96VA constant load will not be exceeded !

- FL - Presser foot lifting  
 RD100 - Signal for Varioreset
- R-SEL - Select resistance 6K8
- DB (E1) - Parameter 240 = 0 => Input function is switched off  
 - Parameter 240 = 1...12 => Various input functions are possible on socket B3/1  
**Factory setting: Parameter 240 = 13 (machine run at limited speed n10)**

1) Nominal voltage 24V, no-load voltage max. 36V

11. Function Diagrams

11.1 Trimming from Full Run and from Intermediate Stop (without Adapter Cord)

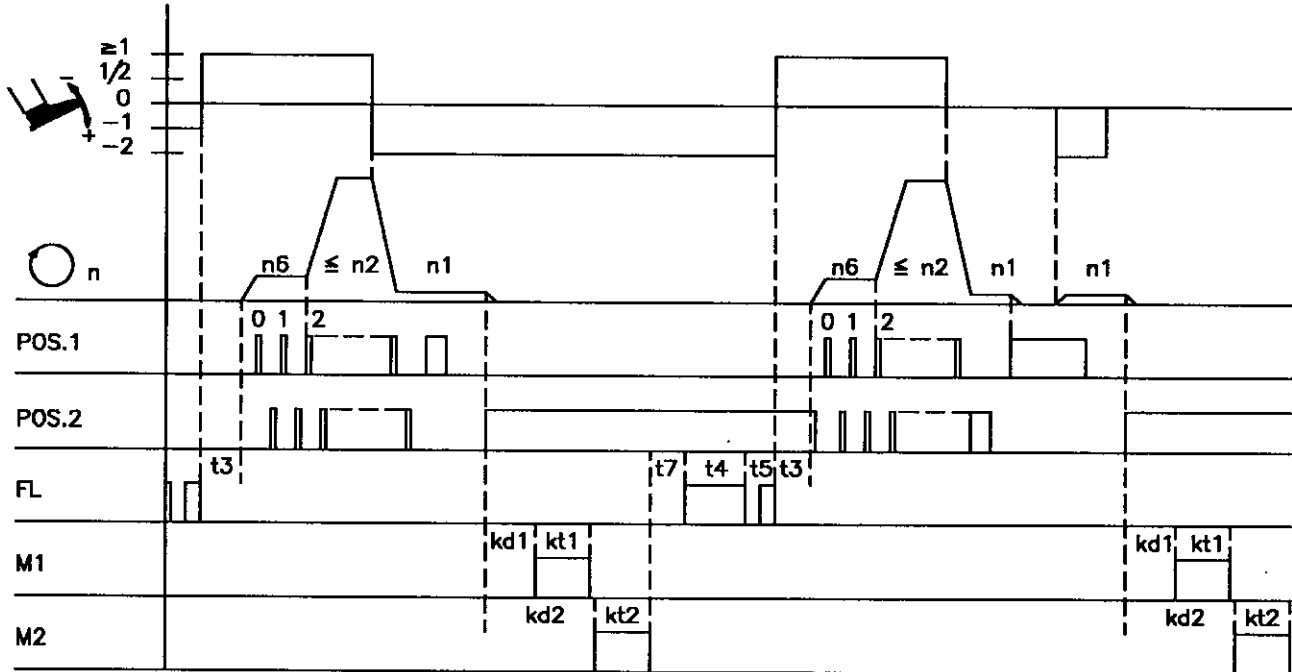

2153/FAZW-0

Abbreviation	Function	Parameter	Pushbutton Control
	Softstart On Thread trimming On	LED 1 on LED 3 on	Pushbutton S2 Pushbutton S3
n1 n2 n6	Positioning speed Maximum speed Softstart speed	110 111 115	
t3 t4 t5 t7	Start delay after presser foot lifting Full power of presser foot lifting Holding power of presser foot lifting Delay thread trimmer end until presser foot lifting	202 203 204 286	
kd1 kt1	Delay time for M1 Activation time for M1	280 281	
kd2 kt2	Delay time for M2 Activation time for M2	282 283	

## 11.2 Light Barrier Sensing (without Adapter Cord)

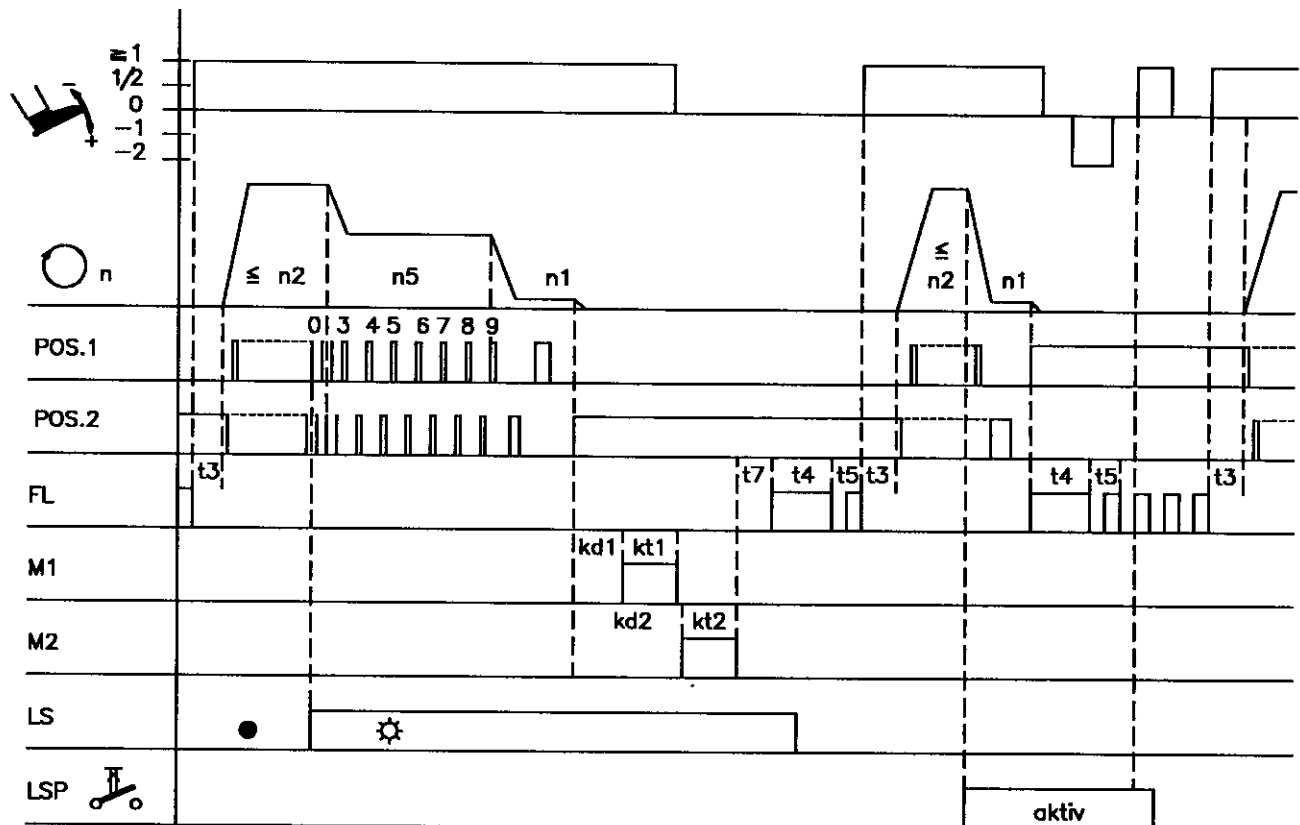

2153/ENDELS-0

Abbreviation	Function	Parameter	Pushbutton Control
	Light barrier On Thread trimming On	LED 3 on 009	Pushbutton S3
n1	Positioning speed	110	
n2	Maximum speed	111	
n5	Speed after light barrier sensing	114	
t3	Start delay after presser foot lifting	202	
t4	Full power of presser foot lifting	203	
t5	Holding power of presser foot lifting	204	
t7	Delay thread trimmer end until presser foot lifting	286	
kd1	Delay time for M1	280	
kt1	Activation time for M1	281	
kd2	Delay time for M2	282	
kt2	Activation time for M2	283	

11.3 Trimming from Full Run and from Intermediate Stop (with Adapter 1112555)

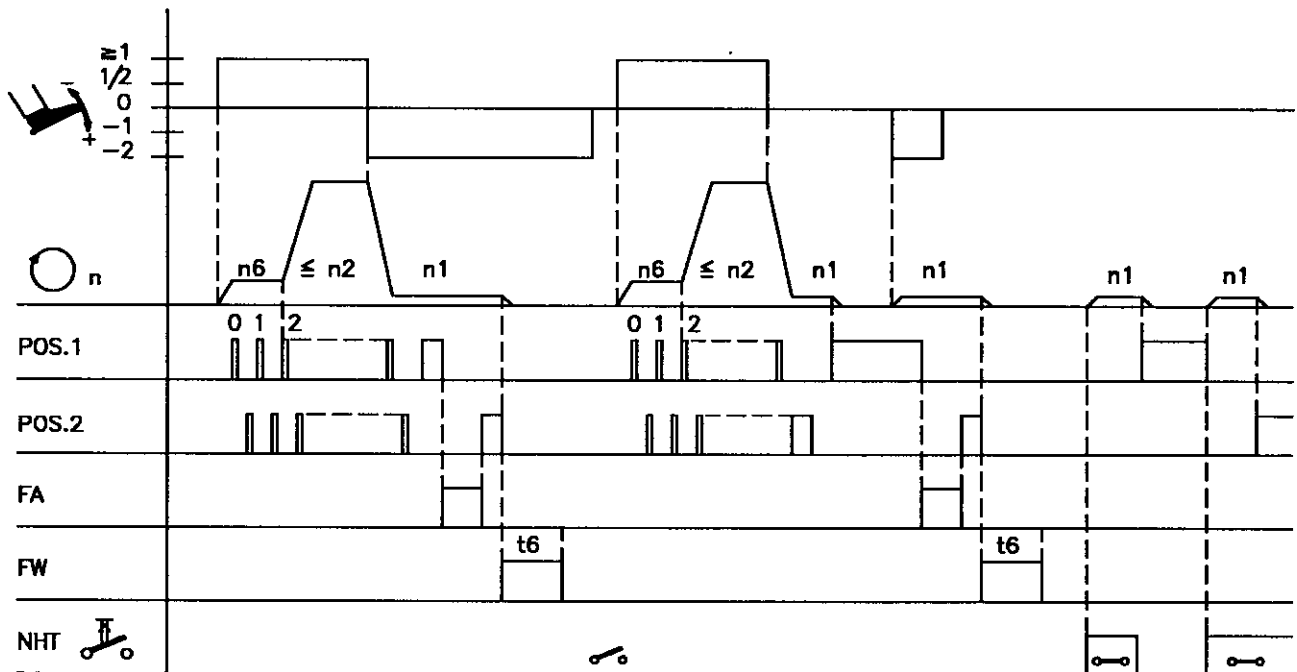

2153/FAZW-1

Abbreviation	Function	Parameter	Pushbutton Control
	Softstart On Thread trimming On	LED 1 on LED 3 on	Pushbutton S2 Pushbutton S3
n1	Positioning speed	110	
n2	Maximum speed	111	
n6	Softstart speed	115	
t6	Activation time thread wiper	205	

### 11.4 Light Barrier Sensing (with Adapter 1112555)

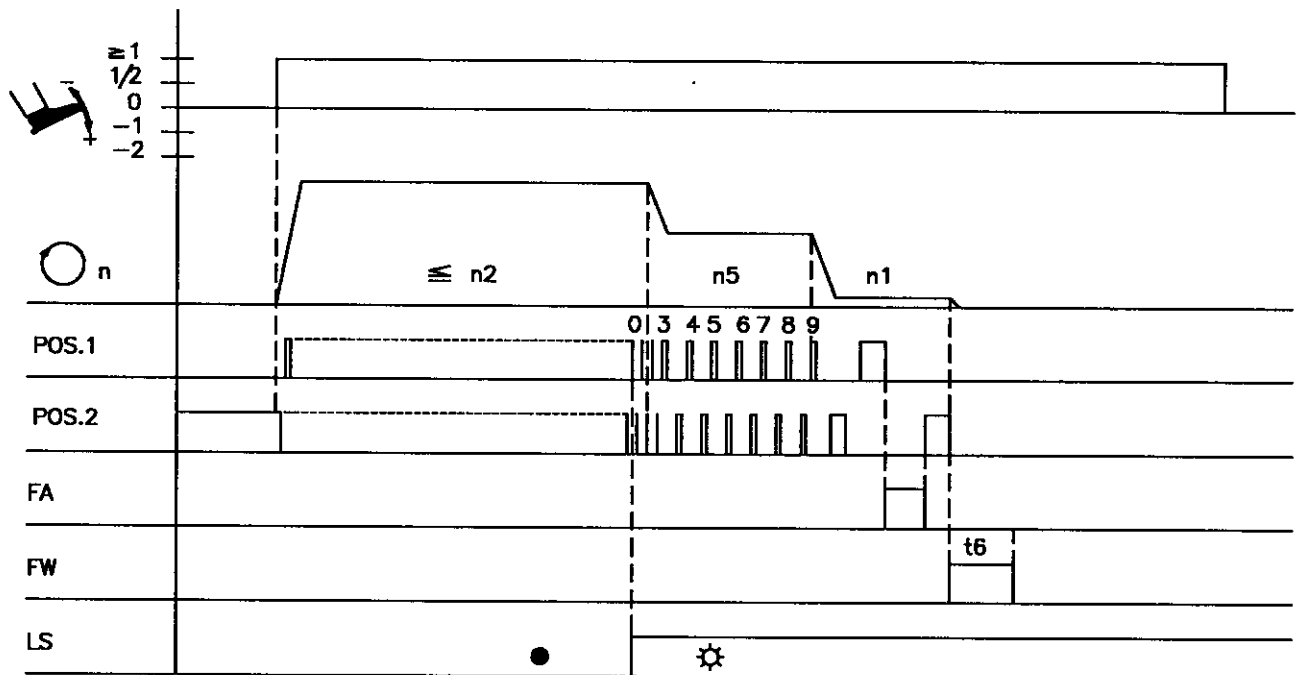

2153/ENDELS-1

Abbreviation	Function	Parameter	Pushbutton Control
	Light barrier On Thread trimming On	LED 3 on 009	Pushbutton S3
n1	Positioning speed	110	
n2	Maximum speed	111	
n5	Speed after light barrier sensing	114	
t6	Activation time thread wiper	205	

11.5 Trimming from Full Run and from Intermediate Stop (with Adapter 1112551)

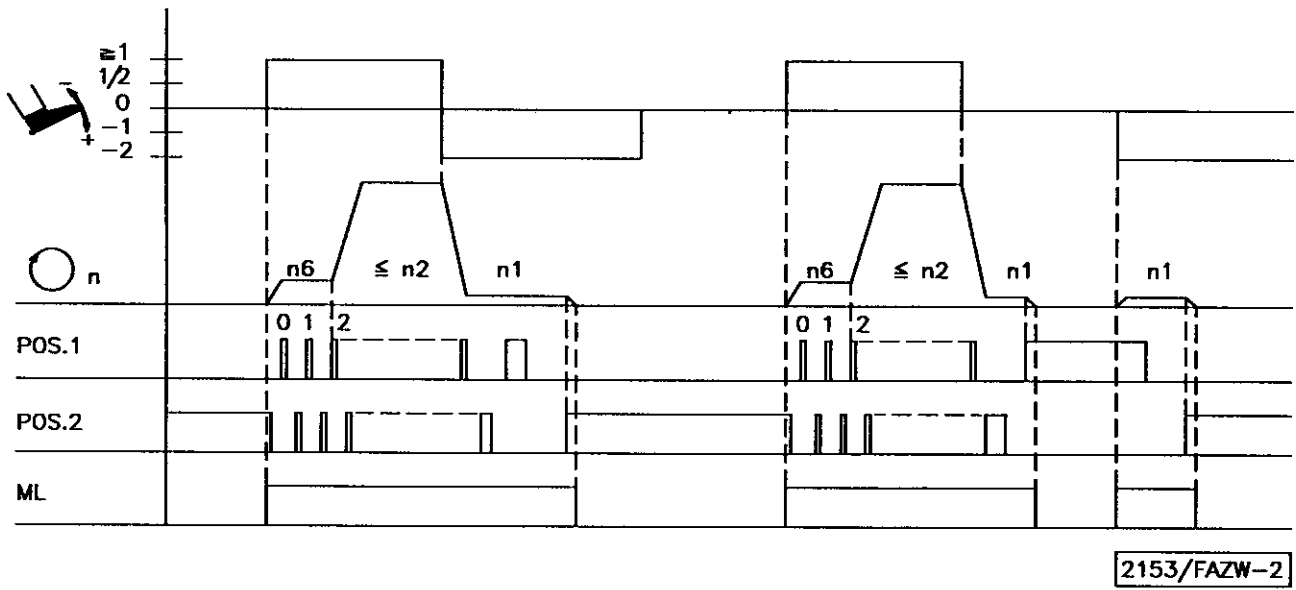

Abbreviation	Function	Parameter	Pushbutton Control
	Softstart On	LED 1 on	Pushbutton S2
n1	Positioning speed	110	
n2	Maximum speed	111	
n6	Softstart speed	115	

### 11.6 Light Barrier Sensing (with Adapter 1112551)

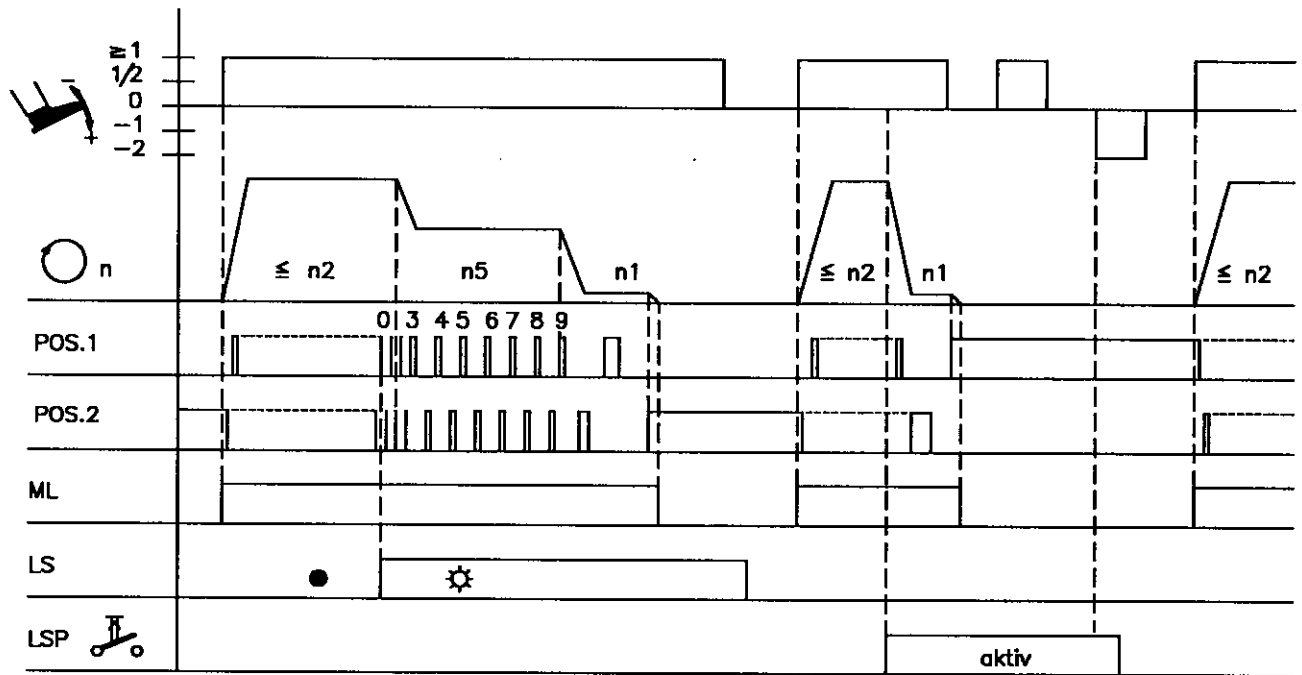

2153/ENDELS-2

Abbreviation	Function	Parameter	Pushbutton Control
	Light barrier On	009	
n1	Positioning speed	110	
n2	Maximum speed	111	
n5	Speed after light barrier sensing	114	



11.7 Trimming from Full Run and from Intermediate Stop (with Adapter 1112545)

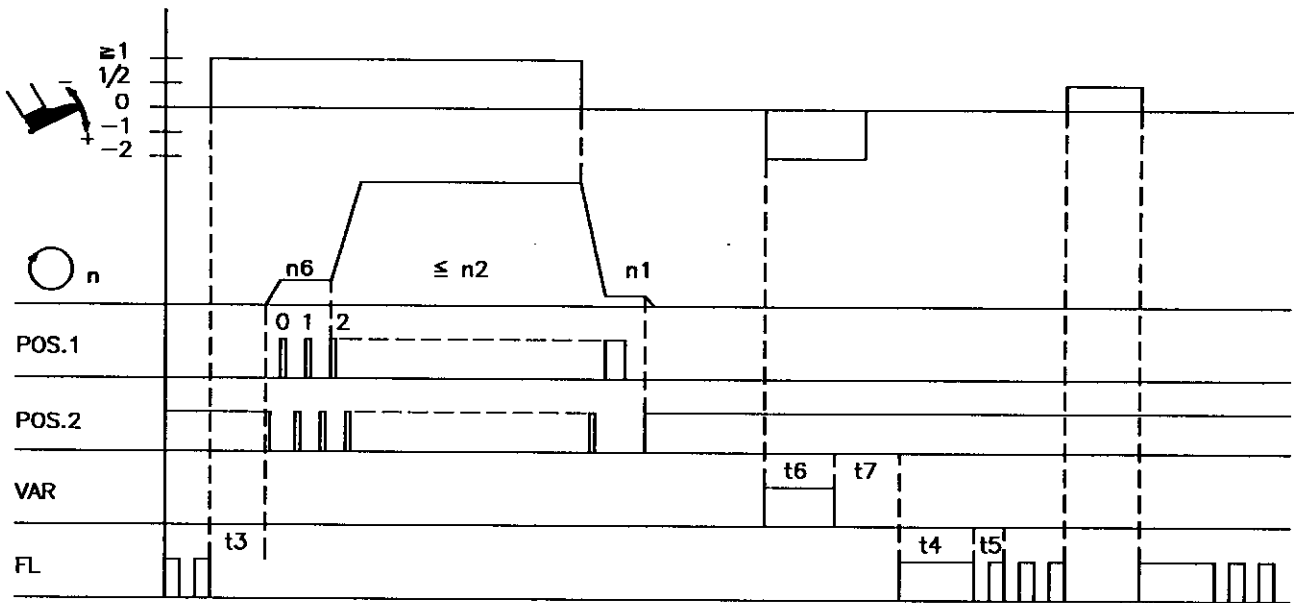

2153/FAZW-3

Abbreviation	Function	Parameter	Pushbutton Control
	Softstart On	LED 1 on	Pushbutton S2
n1	Positioning speed	110	
n2	Maximum speed	111	
n6	Softstart speed	115	
t3	Start delay after presser foot lifting	202	
t4	Full power of presser foot lifting	203	
t5	Holding power of presser foot lifting	204	
t6	Activation time Varioreset	205	
t7	Delay after Varioreset until presser foot lifting	206	

## 11.8 Light Barrier Sensing (with Adapter 1112545)

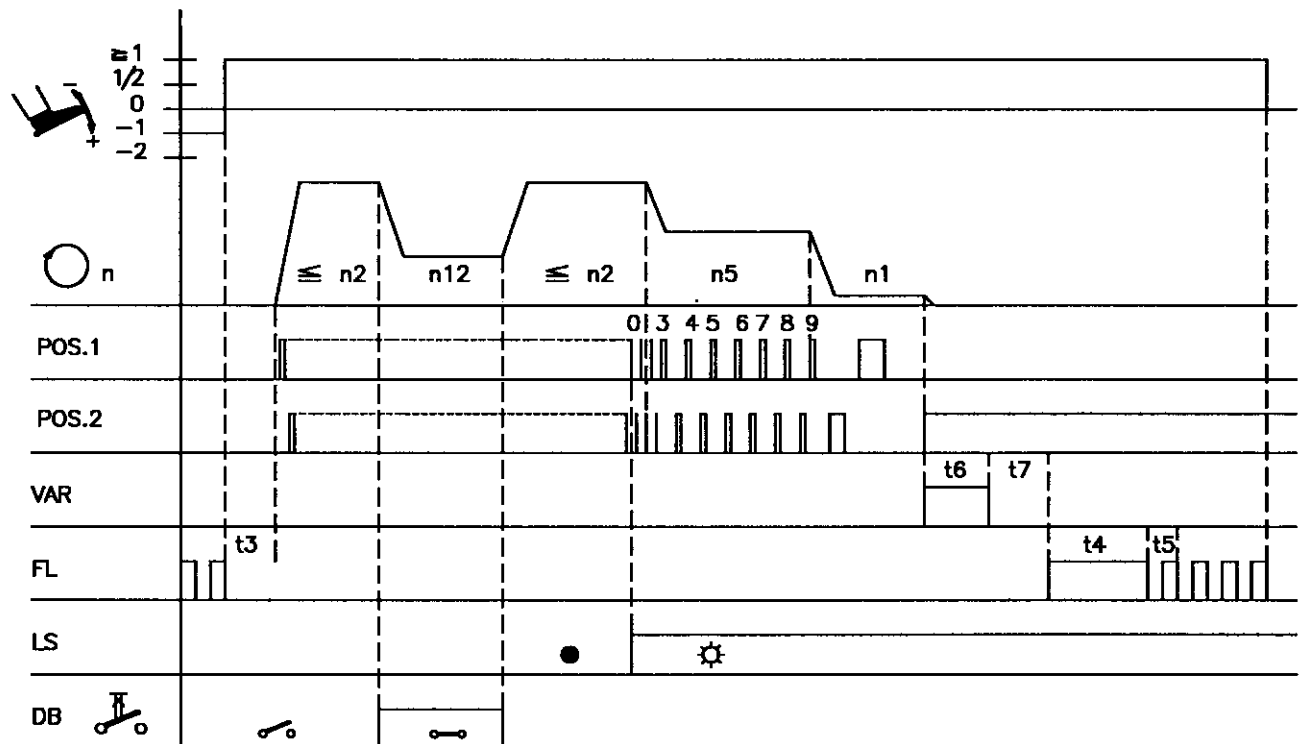

2153/ENDELS-3

Abbreviation	Function	Parameter	Pushbutton Control
	Light barrier On	009	
n1	Positioning speed	110	
n2	Maximum speed	111	
n5	Speed after light barrier sensing	114	
t3	Start delay after presser foot lifting	202	
t4	Full power of presser foot lifting	203	
t5	Holding power of presser foot lifting	204	
t6	Activation time Varioreset	205	
t7	Delay after Varioreset until presser foot lifting	206	

## 12. Parameter List

### 12.1 OPERATOR LEVEL

Parameter	Designation	Unit	max	min	Preset	Ind. Prg. No.
004 LS	Light barrier compensating stitches		254	0	7	A
005 LSF	Number of stitches of the light barrier filter for knitted fabrics		254	0	0	A
009 LS	Light barrier	ON/OFF			OFF	A

### 12.2 TECHNICIAN LEVEL

Code no. 190 with control operation

Parameter	Designation	Unit	max	min	Preset	Ind. Prg. No.
<b>Group 0 Stitches/Countings</b>						
100 SSc	Number of softstart stitches		20	0	2	A
<b>Group 1 Speeds</b>						
110 n1	Positioning speed	RPM	390 *)	70	180	A
111 n2-	Upper limit setting range maximum speed	RPM	9900 *)	n2_	3000	A
114 n5	Speed after light barrier sensing	RPM	9900 *)	200	1500	A
115 n6	Softstart speed	RPM	1500 *)	70	400	A
117 n10	Limited and/or automatic speed	RPM	9900 *)	200	2000	A
119	Speed stage graduation 1 = linear 2 = slightly progressive 3 = highly progressive		3	1	2	A
<b>Group 2 Speeds</b>						
121	Lower limit setting range maximum speed	RPM	n2- *)	400	400	A

\*) When programming the 4-digit control parameter values the 3-digit value displayed must be multiplied by 10.

## TECHNICIAN LEVEL continued

Code no. 190 with control operation

Parameter	Designation	Unit	max	min	Preset	Ind. Prg. No.
<b>Group 3 Switching functions</b>						
132	Blocking of machine start, when light barrier "uncovered"	ON/OFF			OFF	A
<b>Group 4 Switching functions</b>						
142	Speed status for the free seam and for the seam with light barrier 0 = speed controllable by the pedal up to the set maximum speed (parameter 111) 1 = fixed speed (parameter 117) without influence by the pedal (machine stop by pushing the pedal to the basic position) 2 = limited speed controllable by the pedal up to the set limit (parameter 117) 3 = at fixed speed (parameter 117), can be interrupted by full heelback (function only if parameter 009 = ON and 242 = 0)		3	0	0	A
<b>Group 5 Time functions</b>						
153	Braking power at machine standstill		50	0	0	A
<b>Group 7 Service functions</b>						
172	Display of the signal position 1 to 1A (LED 7 below pushbutton >> lights up) or position 2 to 2A (LED 8 below pushbutton >> lights up)					A
173	Checking of the inputs and outputs OFF/ON = Input test o01 = Output M1/motor running/thread trimmer/Varioreset o02 = Output M2 o03 = free o04 = free o05 = Presser foot lifting/thread wiper					A

**12.3 SUPPLIER LEVEL**

Code no. 311 with control operation

Parameter	Designation	Unit	max	min	Preset	Ind. Prg. No.	
<b>Group 0 Time functions</b>							
201	t2	Activation delay of presser foot lifting with half heelback	ms	990	20	80	A
202	t3	Start delay after presser foot lifting	ms	990	0	80	A
203	t4	Time of full power of presser foot lifting	ms	990	0	400	A
204	t5	Holding power for presser foot lifting Stages 1...7 Stage 1 = 12.5% Stage 7 = 87.5%  Stage 1 = low holding power Stage 7 = high holding power		7	1	3	A
205	t6	Activation time thread wiper and/or Varioreset	ms	990	0	120	A
206	t7	Delay after Varioreset signal until presser foot lifting	ms	990	0	80	A
207		Braking effect with speed jumps $\leq 800$ RPM		255	1	40	A
208		Braking effect when modifying the preset value $\geq 800$ RPM		255	1	80	A
<b>Group 2 Speeds</b>							
220		Accelerating power of the drive		255	1	80	A
221		Speed gate (difference from the positioning speed)		990 *)	50	100	A
222		Speed gate damping period	ms	990	0	140	A
<b>Group 3 Switching functions</b>							
231		Execution of the set stitches after power ON at positioning speed		3	0	0	A

\*) When programming the 4-digit control parameter values, the 3-digit value displayed must be multiplied by 10.

**SUPPLIER LEVEL continued**

Code no. 311 with control operation

Parameter	Designation	Unit	max	min	Preset	Ind. Prg. No.
<b>Group 4      Switching functions</b>						
240	<b>Selection of the input function on socket B3/1</b> 0 = Input blocked 1 = Needle up/down 2 = Needle up 3 = Single stitch (basting stitch) 4 = Full stitch 5 = Needle to position 2 6 = Blocking of machine run effective with open contact 7 = Blocking of machine run effective with closed contact 8 = Blocking of machine run (unpositioned) effective with open contact 9 = Blocking of machine run (unpositioned) effective with closed contact 10 = Automatic speed without pedal (n10) 11 = Limited speed with pedal (n10) 12 = Presser foot lifting with pedal in position 0 (neutral)		14	0	1	A
242	<b>Selection of the input function on socket B18/5</b> 0 = Light barrier function, if 009 = ON 1 = Needle up/down 2 = Needle up 3 = Single stitch (basting stitch) 4 = Full stitch 5 = Needle to position 2 6 = Blocking of machine run effective with open contact 7 = Blocking of machine run effective with closed contact 8 = Blocking of machine run (unpositioned) effective with open contact 9 = Blocking of machine run (unpositioned) effective with closed contact 10 = Automatic speed without pedal (n10) 11 = Limited speed with pedal (n10) 12 = Presser foot lifting with pedal in pos. 0 (neutral)		14	0	0	A

**SUPPLIER LEVEL continued**

Code no. 311 with control operation

Parameter	Designation	Unit	max	min	Preset	Ind. Prg. No.
<b>Group 8 Time functions for chainstitch</b>						
280	kd1	Delay time output M1	2550 *)	0	0	A
281	kt1	Activation time output M1	2550 *)	0	110	A
282	kd2	Delay time output M2	2550 *)	0	130	A
283	kt2	Activation time output M2	2550 *)	0	110	A
286	t7	Delay time until presser foot 0n	2550 *)	0	80	A

\*) When programming the 4-digit control parameter values, the 3-digit value displayed must be multiplied by 10.

### 13. Operating Elements and Socket Connectors

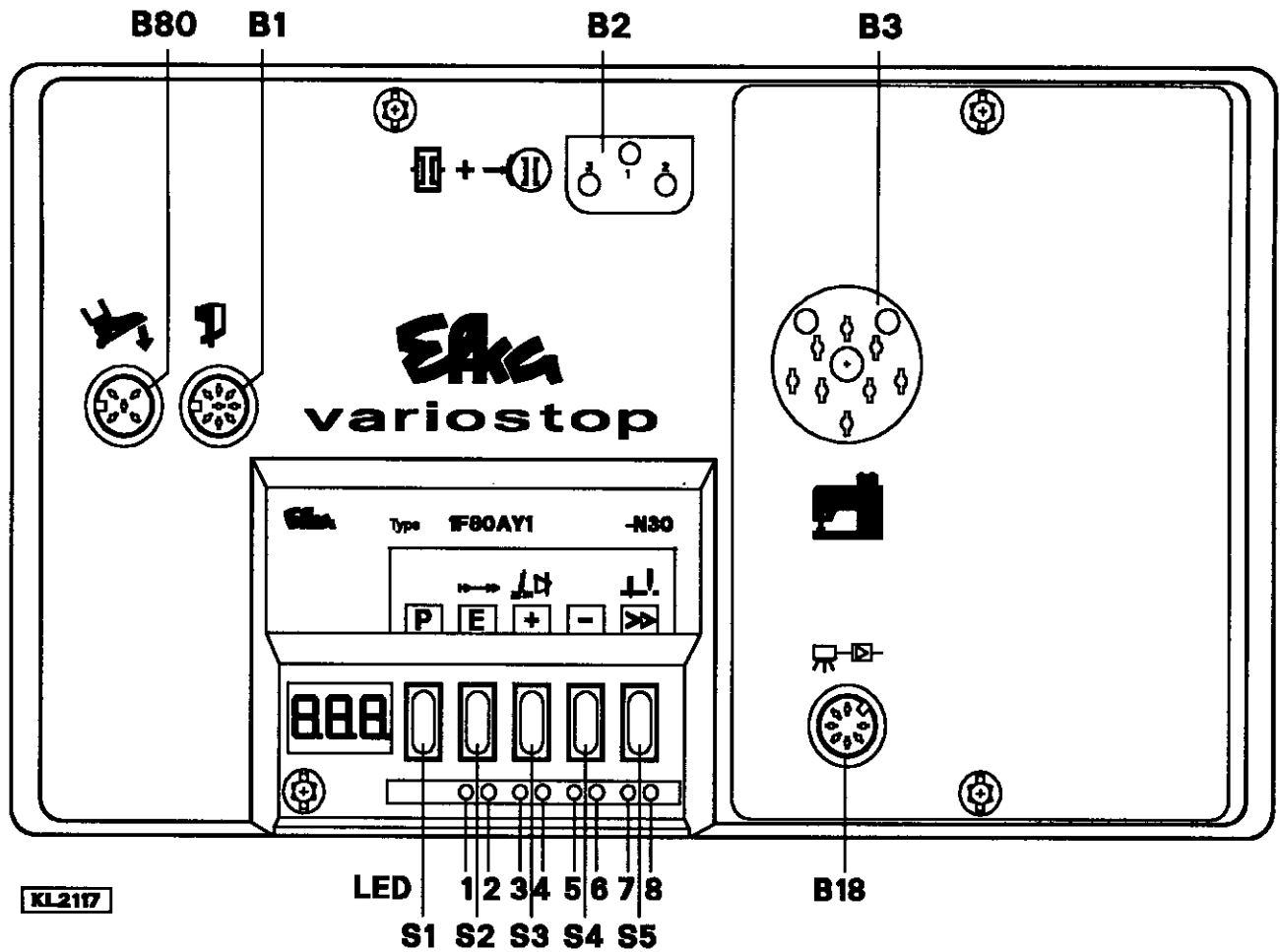

- B1 - Position transmitter
- B2 - Clutch/brake of the motor
- B3 - Machine
- B18 - Light barrier module
- B80 - Actuator
  
- S1..S5 - Pushbuttons for programming and selection of functions
  
- LED 1..8 - Indicators for switched on functions



---

**EFKA**

FRANKL & KIRCHNER GMBH & CO KG  
SCHEFFELSTRASSE 73 - 68723 SCHWETZINGEN  
TEL.: (06202)2020 - TELEFAX: (06202)202115 - TELEX: 466314

**EFKA**

OF AMERICA INC.  
3715 NORTHCREST ROAD - SUITE 10 - ATLANTA - GEORGIA 30340  
PHONE: (404)457-7006 - TELEFAX: (404)458-3899 - TELEX: EFKA AMERICA 804494

**EFKA**

ELECTRONIC MOTORS SINGAPORE PTE. LTD.  
67, AYER RAJAH CRESCENT 05-03 - SINGAPORE 0513  
PHONE: 7772459 or 7789836 - TELEFAX: 7771048

1(1)-200995-A(402164EN)