

Efka motor DC1210 at sewing machine JUKI MO68

## 1 Remove not required parts from sewing machine

### 1.1 Remove 3 cylindrical head screws (accessories from JUKI)

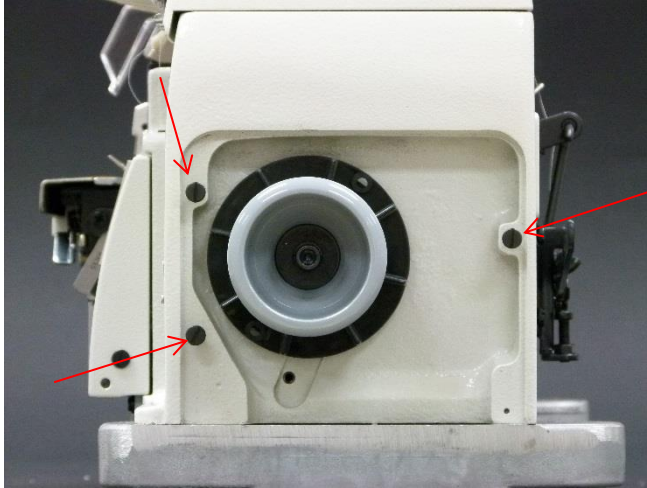

Remove pulley with hand wheel

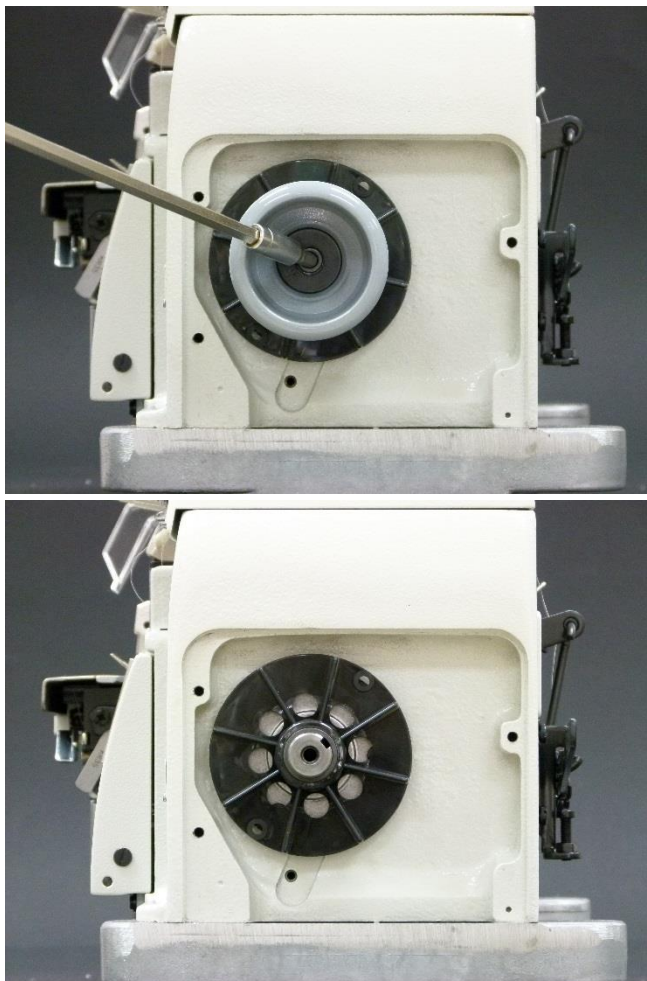

Efka motor DC1210 at sewing machine JUKI MO68

## 2 Mount flat adapter plate

Mount flat adapter plate with the 3 cylindrical head screws from JUKI, that you dismantled at the beginning

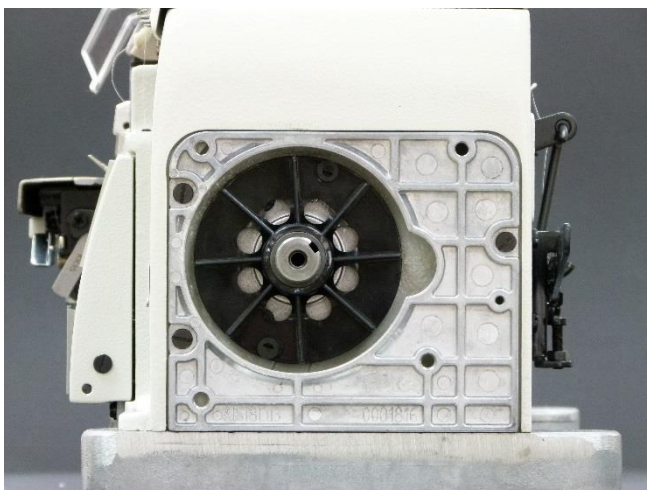
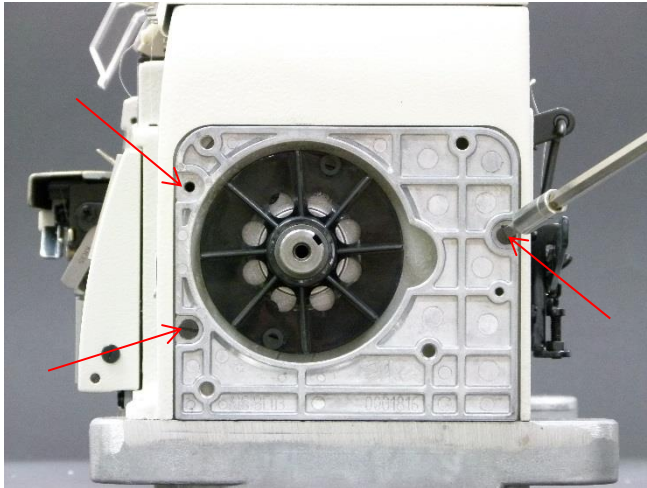

Efka motor DC1210 at sewing machine JUKI MO68

### 3 Mount toothed belt disc

#### 3.1 Add 2 pieces washer 17x24x1,5mm (Efka 1304134)

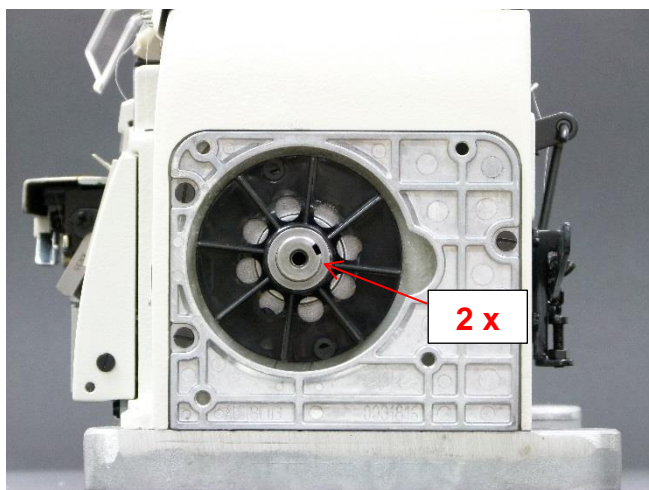
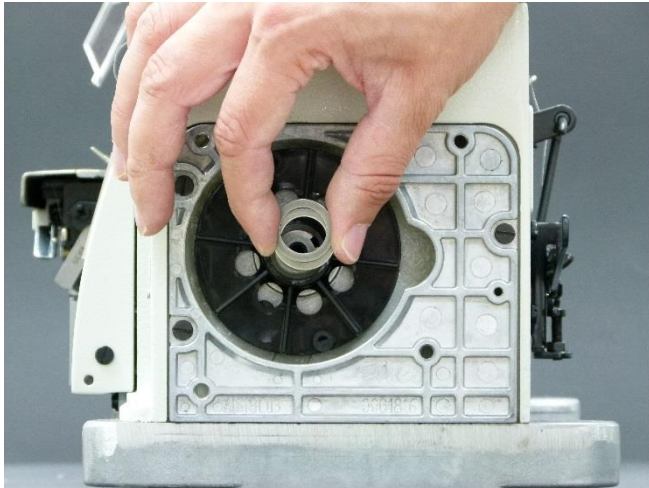

#### 3.2 Add toothed belt disc (Efka 1114073)

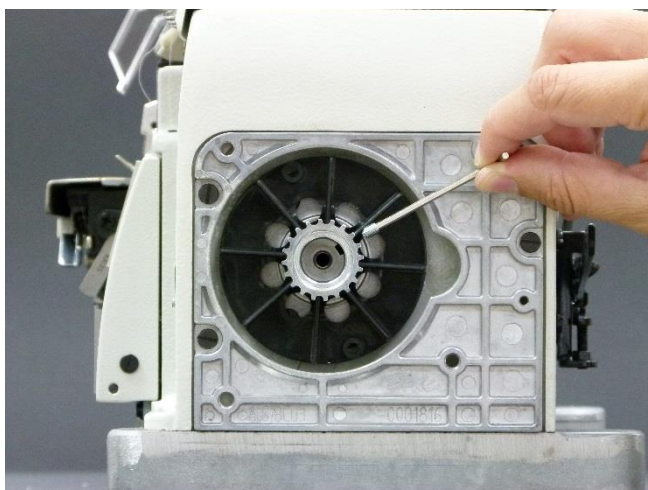



## Efka motor DC1210 at sewing machine JUKI MO68

## 3.3 Fix toothed belt wheel on machine shaft

- 1 pc. Cylindrical screw M6 x 16 (Efka 130100)
- 1 pc. Spring washer DIN 137 B6 (Efka 1300249)
- 1 pc. Washer DIN 9021 A6,4 x 18 x 1,6 (Efka 1304076)

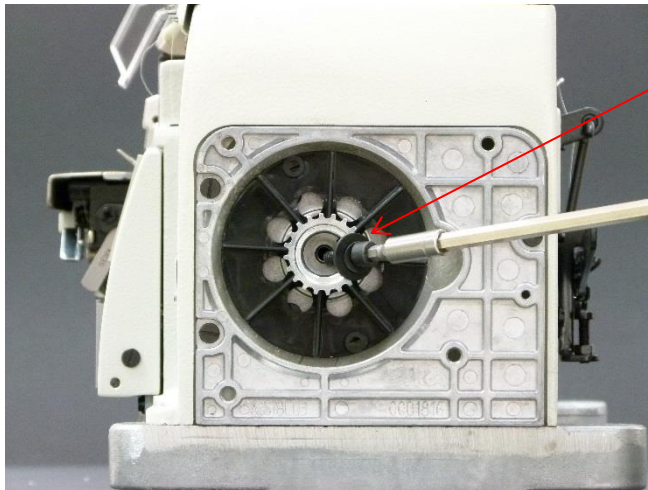

**Torque:  
3 +/- 0,5 Nm**

## 3.4 Fix the 2 headless screws on toothed belt disc

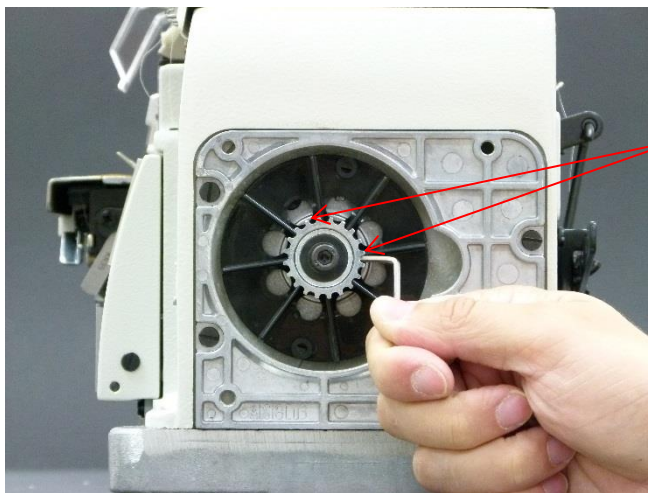

**Torque:  
2 +/- 0,5 Nm**

Efka motor DC1210 at sewing machine JUKI MO68

## 4 Mount main adapter

### 4.1 Fix the adapter with 3 screws on the sewing machine

- 4 pc. Screw DIN 912 M6x12 (Efka 1300894)
- 4 pc. Spring washer DIN 137 B6 (Efka 1300249)
- 4 pc. Washer DIN 125 A6,4 (Efka 1300232)

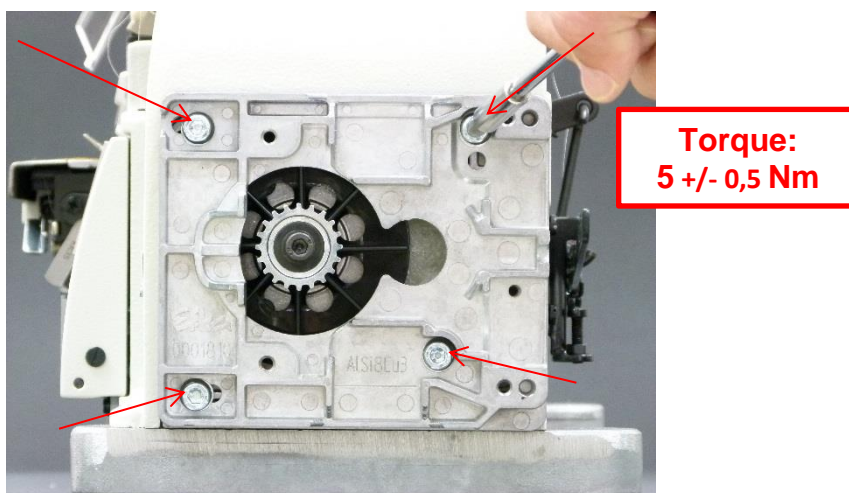
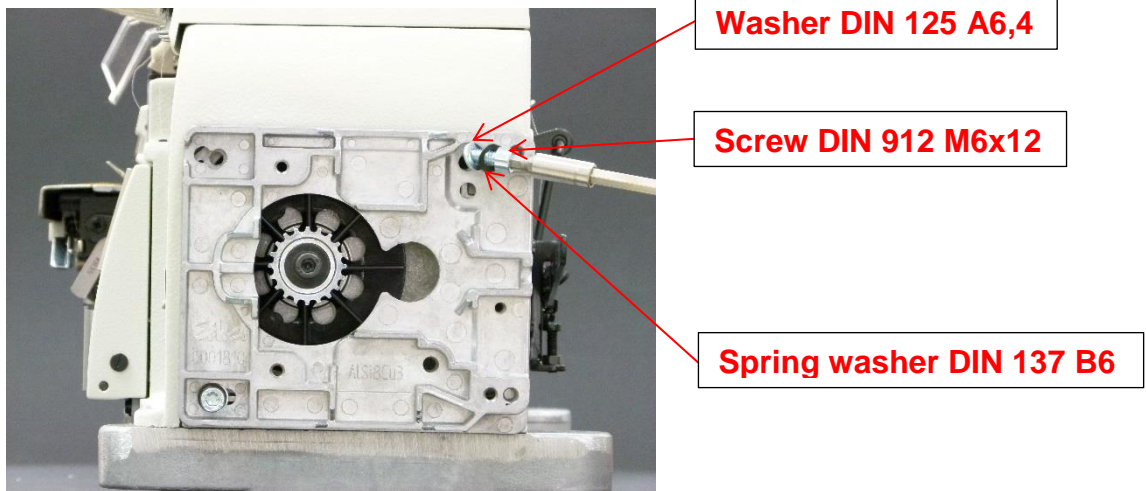

Efka motor DC1210 at sewing machine JUKI MO68

## 5 Mount toothed belt wheel on motor

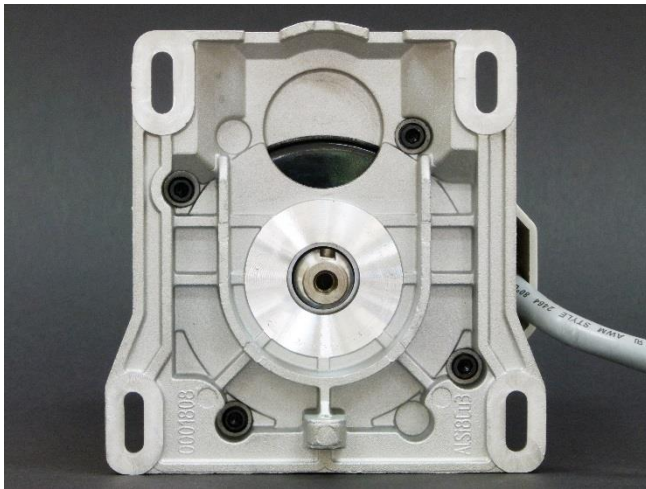

### 5.1 Put woodruff key into the woodruff key slot

- 1 pc. Woodruff key DIN 6888 4x5 (Efka 1300294)

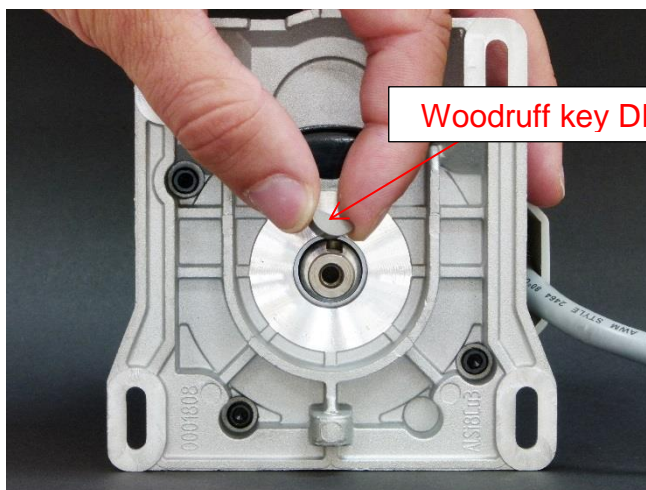

Woodruff key DIN 6888 4x5

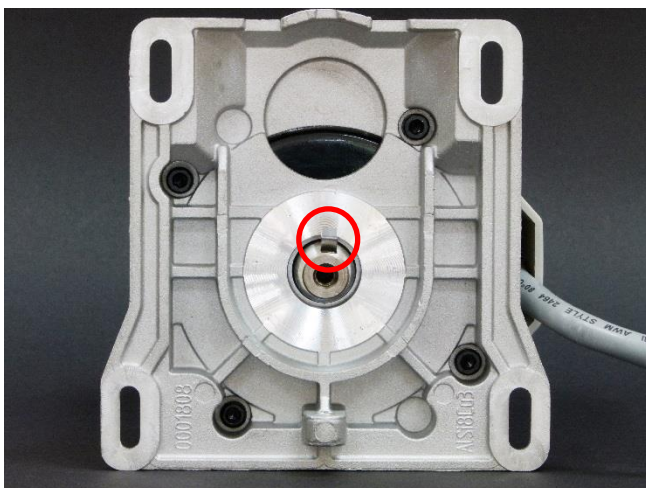

Efka motor DC1210 at sewing machine JUKI MO68

5.2 Push the toothed belt wheel on the drive shaft

- 1 pc. Toothed belt wheel HTD-5M-15, 20 teeth (Efka 0301009)

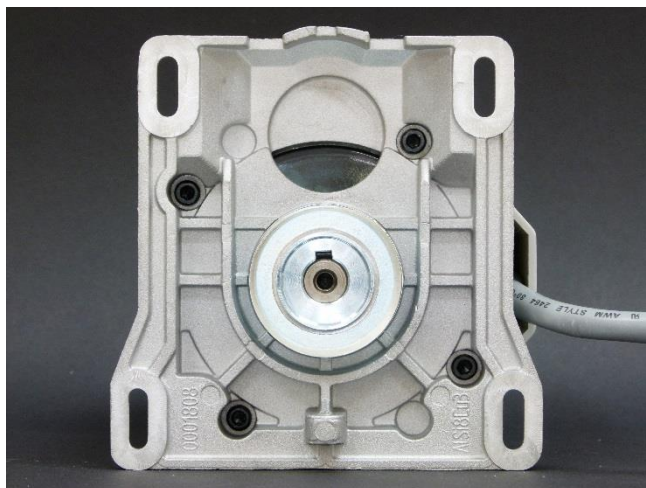
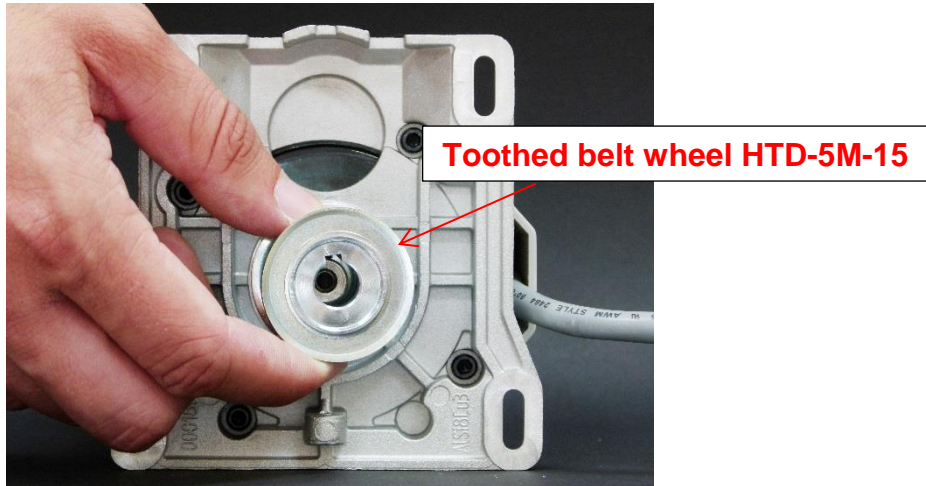



Efka motor DC1210 at sewing machine JUKI MO68

### 5.3 Fix toothed belt wheel on driver shaft

- 1 pc. Screw DIN 7984 M5x12 (Efka 1300699)
- 1 pc. Spring washer DIN 137 B5 (Efka 1300248)
- 1 pc. Washer DIN 9021 A5,3x15x1,2 (Efka 1304141)

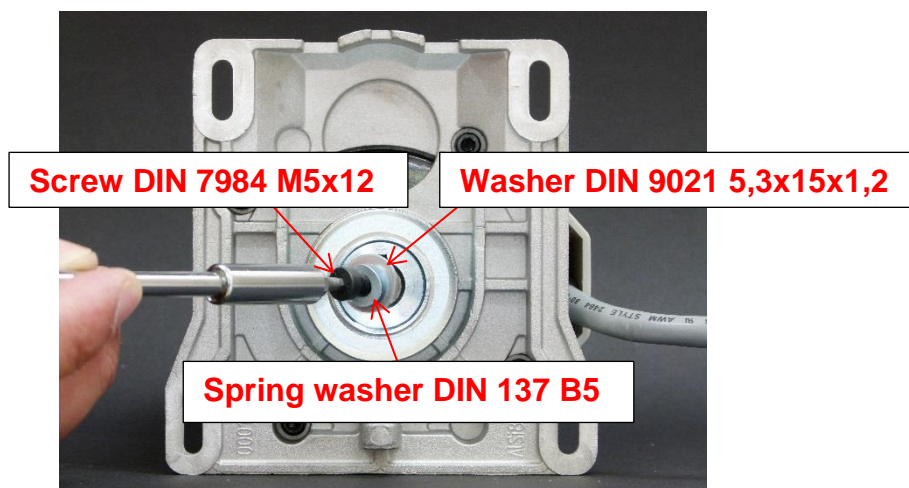

### 5.4 Use toothed belt to fix the toothed belt wheel.

Tight the cylindrical screw.

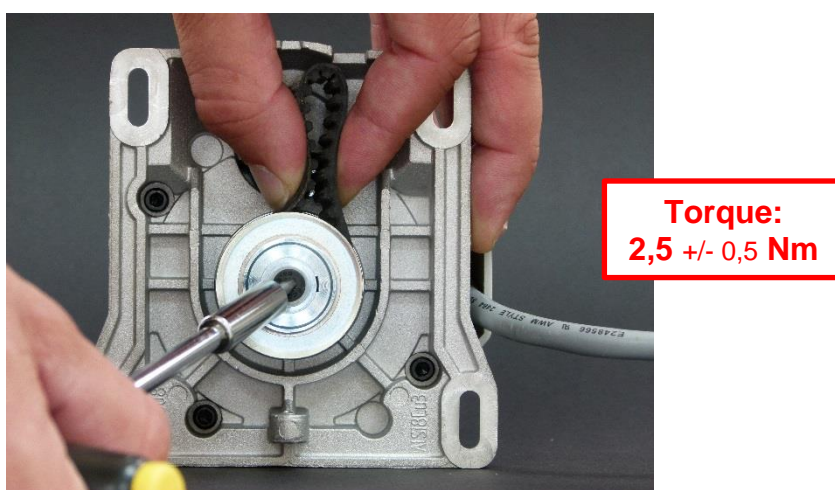



Efka motor DC1210 at sewing machine JUKI MO68

## 6 Mount motor on adapter

6.1 To fix the motor on the adapter, the motor has to be pre-assembled

- Toothed belt disc (Efka 0901009) is mounted on motor shaft
- Toothed belt (Efka 1114073) lays in the space, that is designed for the belt

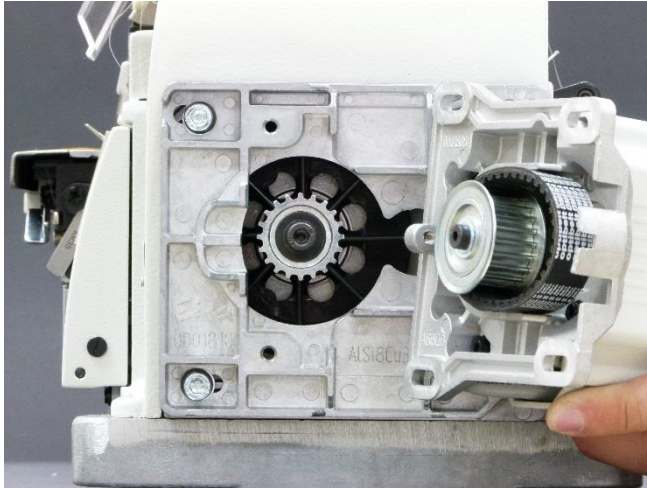

6.2 Mount motor with 4 screws at the adapter

- 4 pc. Screw DIN 7984 M5x12 (Efka 1300699)
- 4 pc. Washer DIN 125 A5,3 (Efka 1304133)
- 4 pc. Spring washer DIN 128 B5 (Efka 1304136)

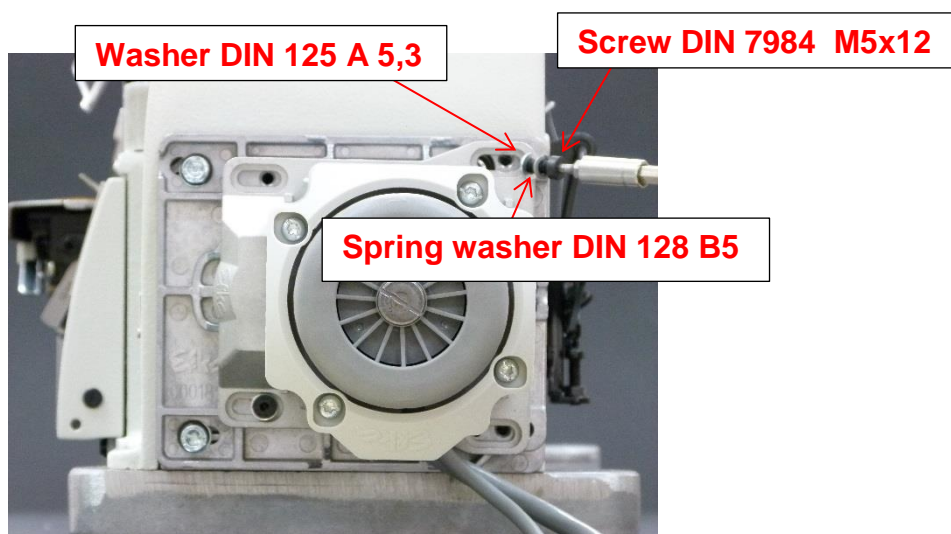

**Do not fasten the screws!** Motor has to move inside the oblong holes.

## Efka motor DC1210 at sewing machine JUKI MO68

## 6.3 Insert the screw, that is used to stretch the belt

- 1 pc. Screw DIN 7984 M5x20 (Efka 1301077)
- 1 pc. Spring washer DIN 137 B5 (Efka 1300248)

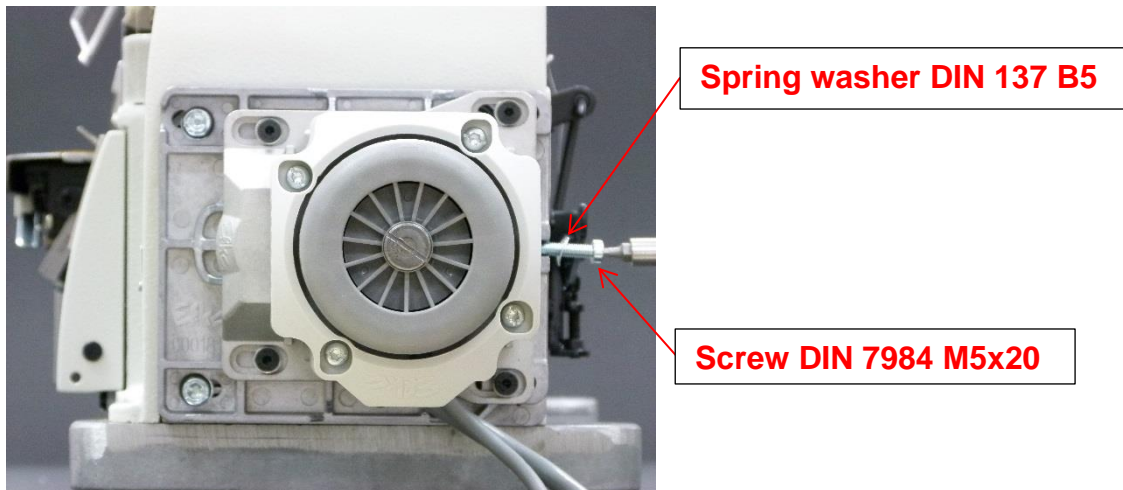

## 6.4 Adjust the motor

Turn handwheel and fasten the screw to stretch the belt.

If the strengt is too strong, while turning the handwheel, you can feel small interruptions. These interruption come from the theeth on wheel and belt.

Reduce the strength from this point just as much, that the belt turns without noticeable interruptions or additional force.

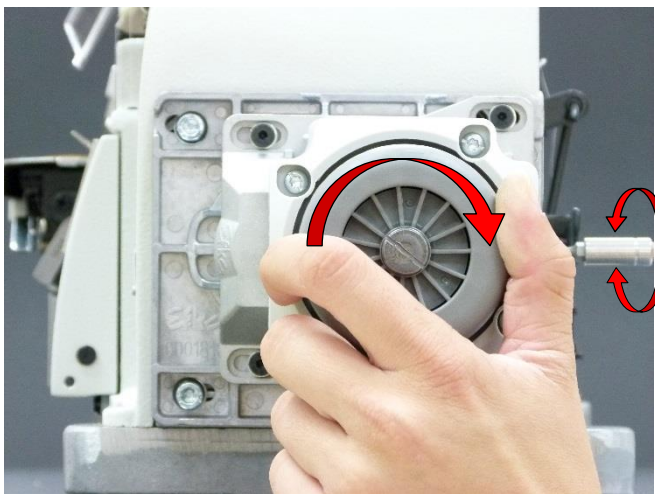

Let the motor turn electrically with the control box about 3000-4000 rpm. Listen to the noise of the motor and the belt. Find the point, where the noise grows up and stop the adjustment just before the noise increases. Target is, not to generate any additional noise from the toothed belt drive.

Efka motor DC1210 at sewing machine JUKI MO68

6.5 Fix the adjusted motor with all 4 screws on the adaper.

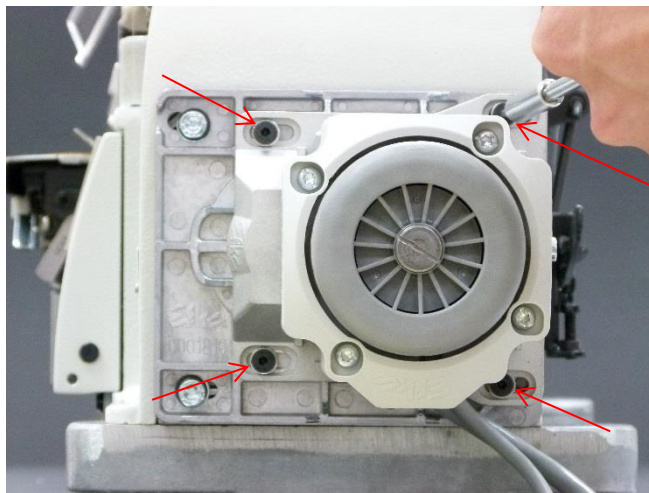

Torque:  
2,5 +/- 0,5 Nm

## 7 Mount air filter

7.1 Insert in every opening an air filter pad.

- 4 pc. Filter pad 10 p/inch 32x23x12mm (EFKA 0207272)

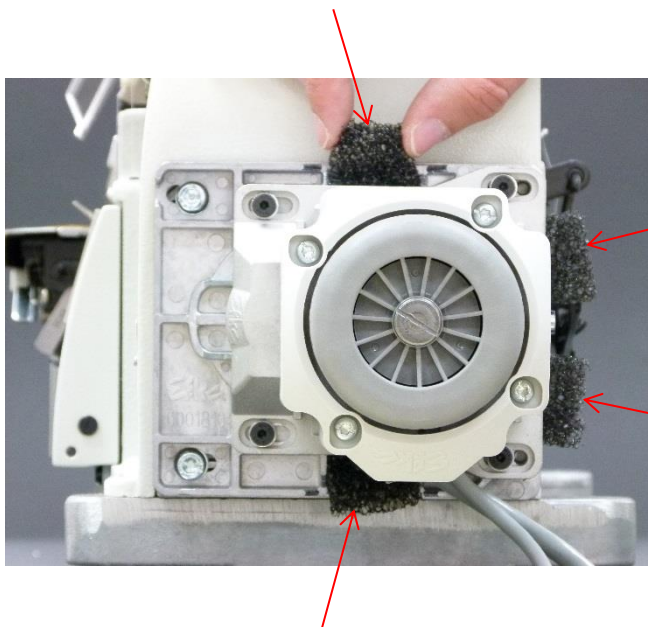

Openings for ventilation  
(photo with filter pads)



Efka motor DC1210 at sewing machine JUKI MO68

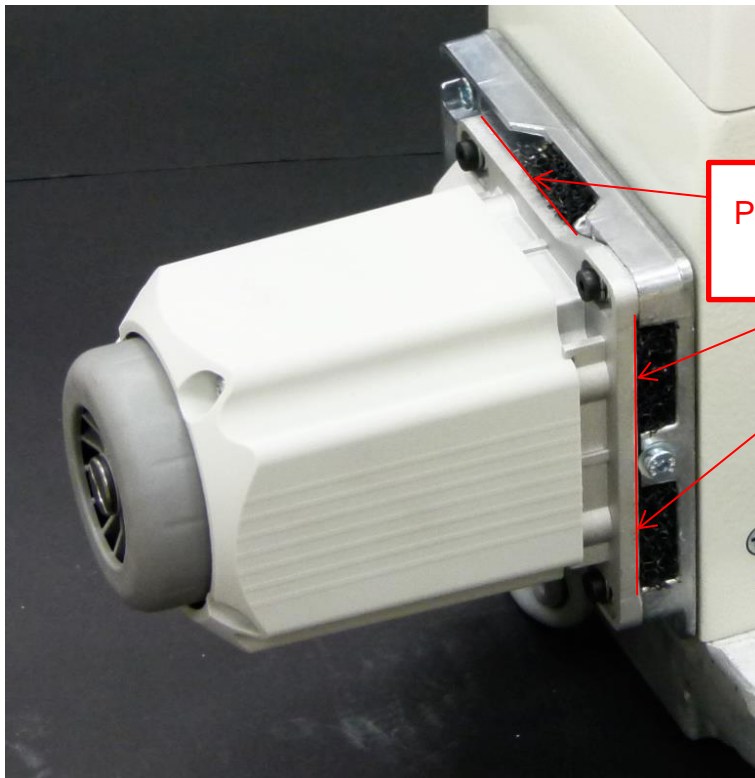

Mounted DC1210 on sewing machine JUKI MO68

