

Efka motor DC1210 at sewing machine Pegasus EX

1 Remove not required parts from sewing machine

1.1 Remove pulley with hand wheel

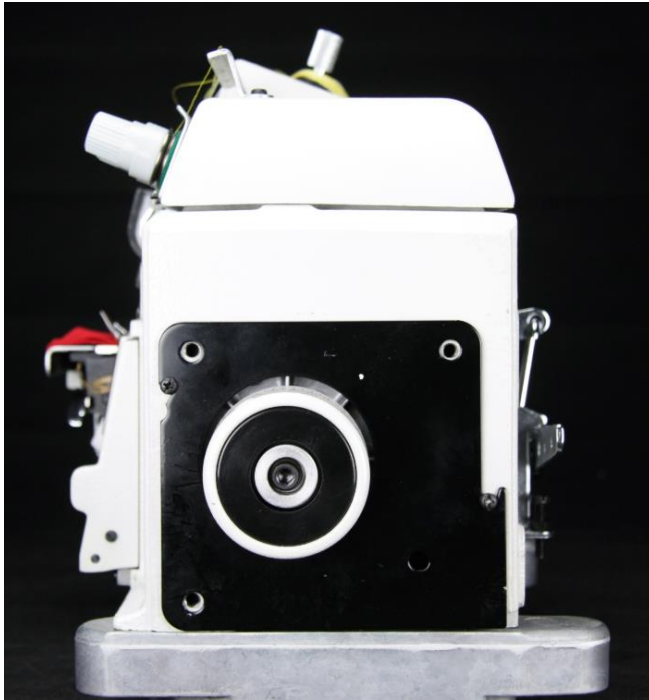

Remove sheet metal fan cover and 2 screws

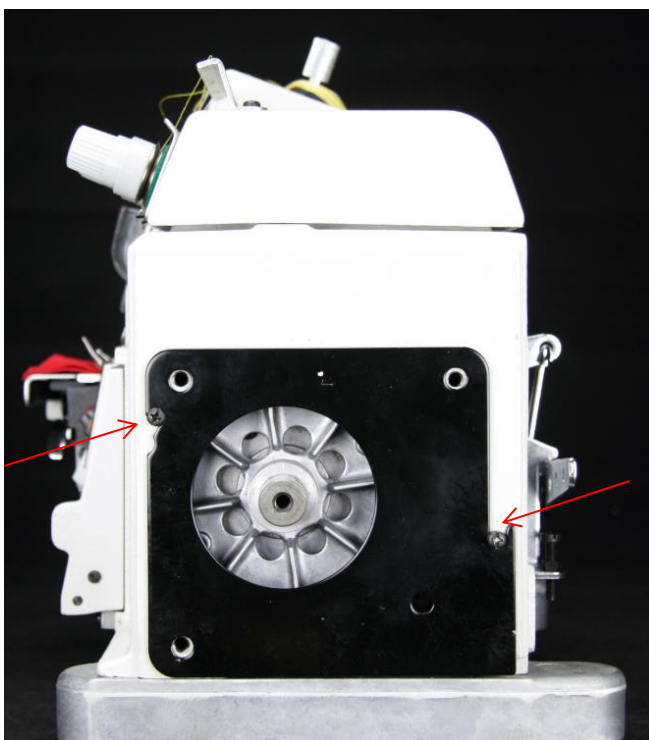

Efka motor DC1210 at sewing machine Pegasus EX

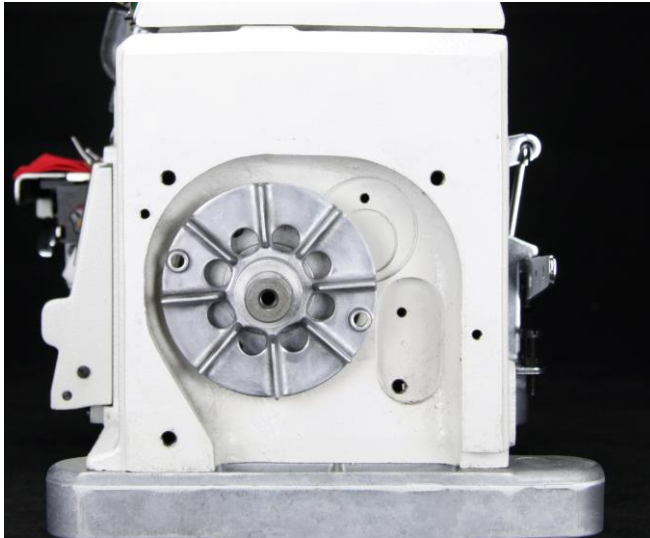

2 Mount toothed belt disc

2.1 Add washer DIN 988 17x24x1,5mm (Efka 1304134)

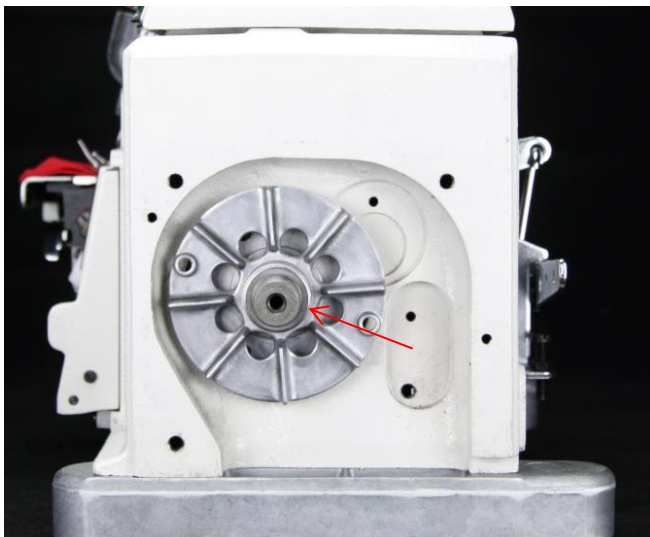
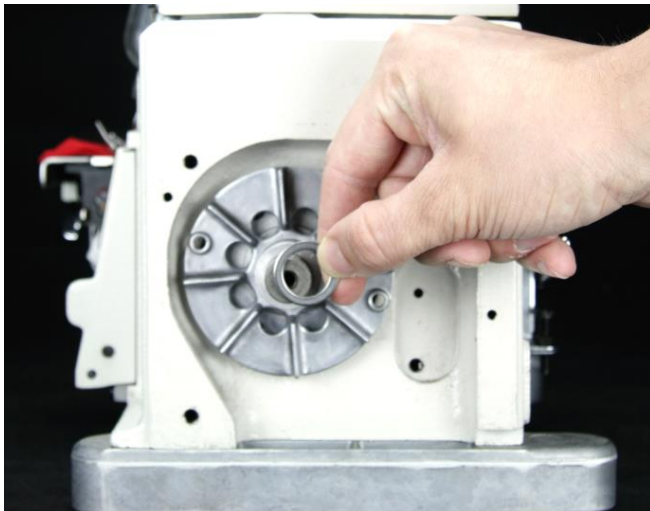

Efka motor DC1210 at sewing machine Pegasus EX

2.2 Add toothed belt disc (Efka 1114073) and adjust it with 2 headless screws.

The initial tightening for the screws has to be low. Do not fasten the screws!

Toothed disc has to move a bit, until the screw in front of the toothed belt disc is fixed.

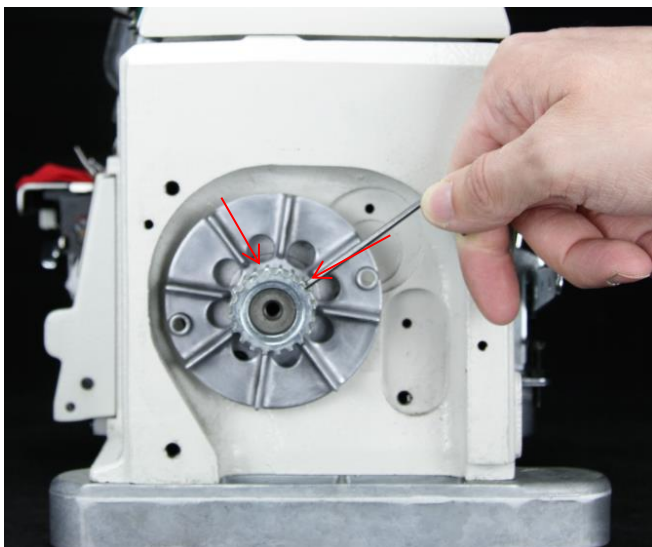

2.3 Add screw in front of the toothed belt disc

- 1 pc. Screw DIN 912 M6x16 (Efka 1301000)
- 1 pc. Washer DIN 9021 A6,4x18x1,6 (Efka 1304076)
- 1 pc. Spring washer DIN 137 B6 (Efka 1300249)

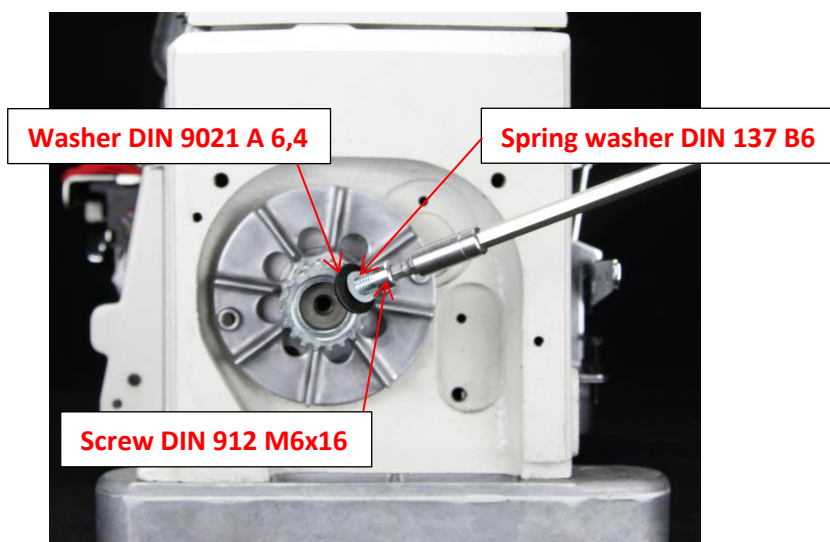

Efka motor DC1210 at sewing machine Pegasus EX

Fix screw in front of the toothed belt disc.

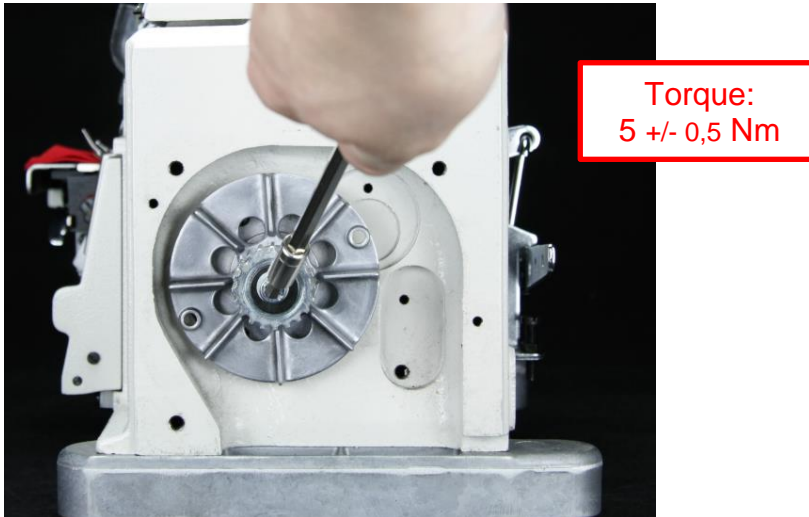

2.4 Fix the 2 headless screws in the toothed belt disc.

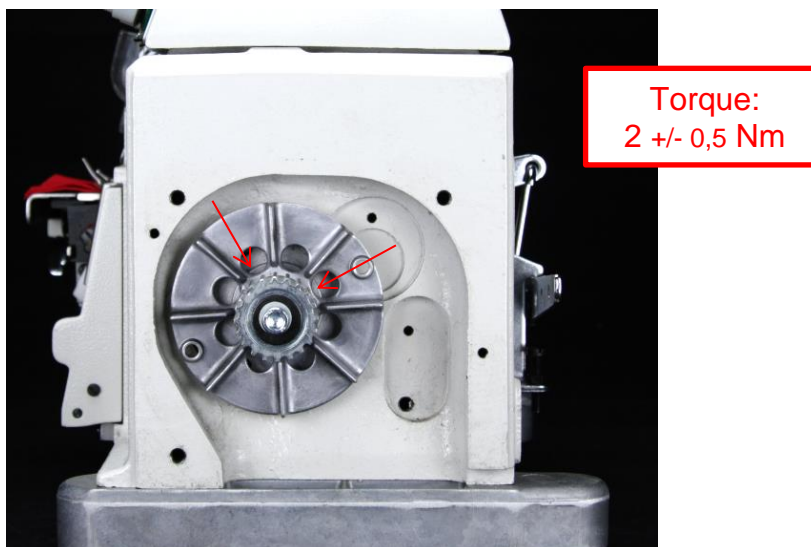

Efka motor DC1210 at sewing machine Pegasus EX

3 Mount adapter

3.1 Fix adapter with 3 screws on sewing machine

- 3 pc. Screw DIN 912 M6x12 (Efka 1300894)
- 3 pc. Washer DIN 125 A6,4 (Efka 1300232)
- 3 pc. Spring washer DIN 137 B6 (Efka 1300249)

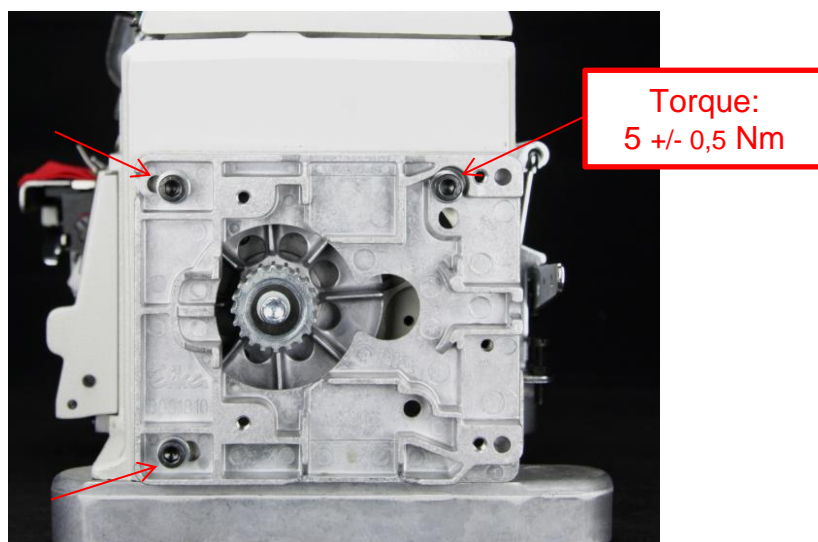
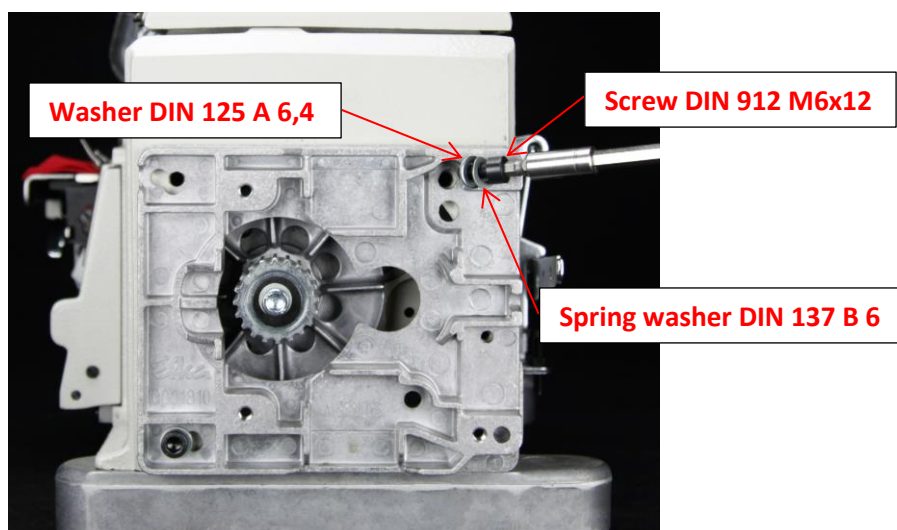

Efka motor DC1210 at sewing machine Pegasus EX

4 Mount toothed belt wheel on motor

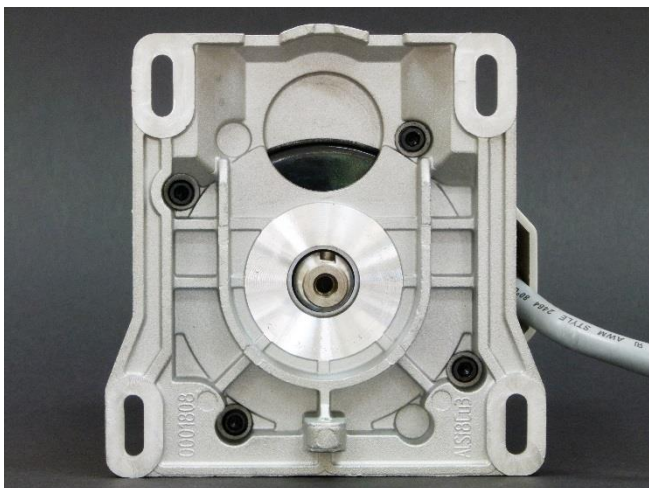

4.1 Put woodruff key into the woodruff key slot

- 1 pc. Woodruff key DIN 6888 (Efka 1300294)

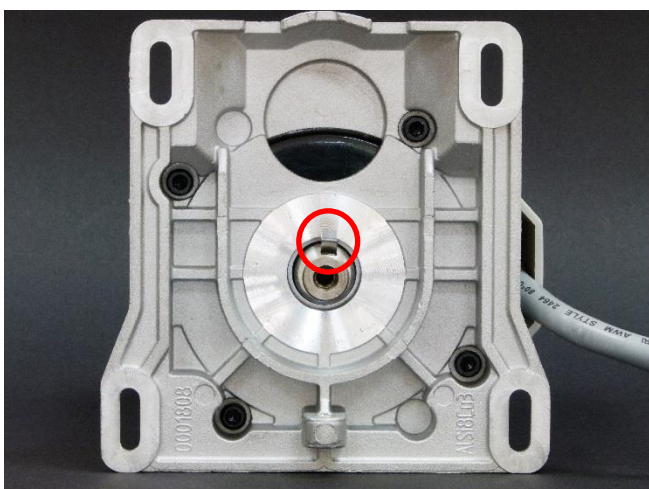
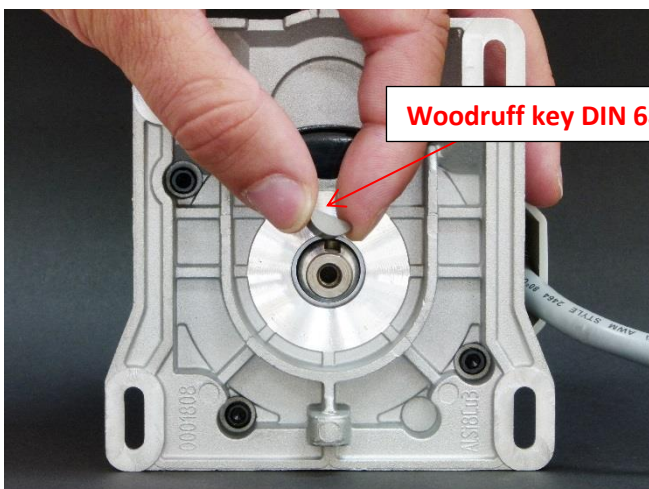

Efka motor DC1210 at sewing machine Pegasus EX

4.2 Push the Toothed belt wheel on the drive shaft

- 1 pc. Toothed belt wheel wheel HTD-5M-15, 20 tooth (Efka 0301009)

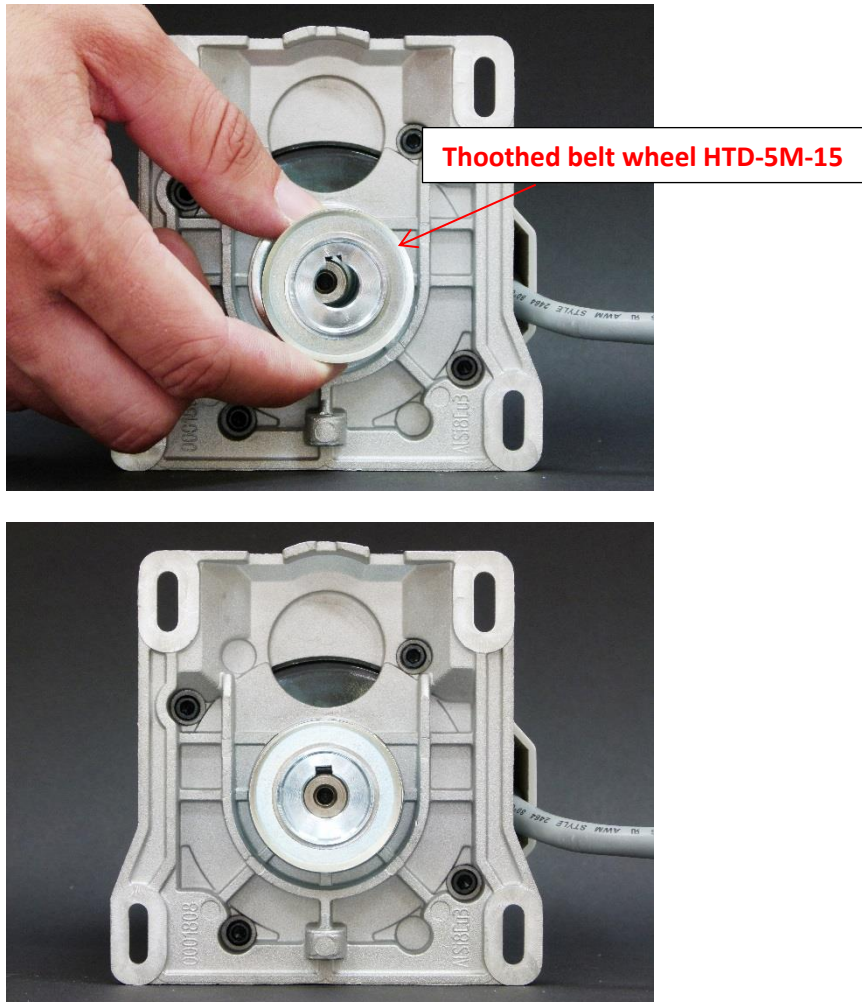

Efka motor DC1210 at sewing machine Pegasus EX

4.3 Fix toothed belt wheel on driver shaft

- 1 pc. Washer A5 3x15x1,2 DIN 9021 (Efka 1304141)
- 1 pc. Cylindrical screw DIN 7984 M6x10 (Efka 1304139)
- 1 pc. Spring washer B5 DIN 137 (Efka 1300248)

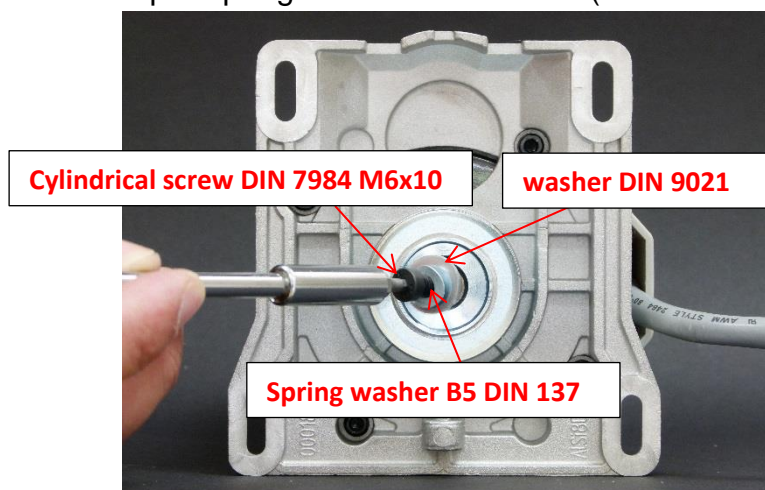

4.4 Use tooth belt to fix the thoothed belt wheel for tighten the cylindrical screw

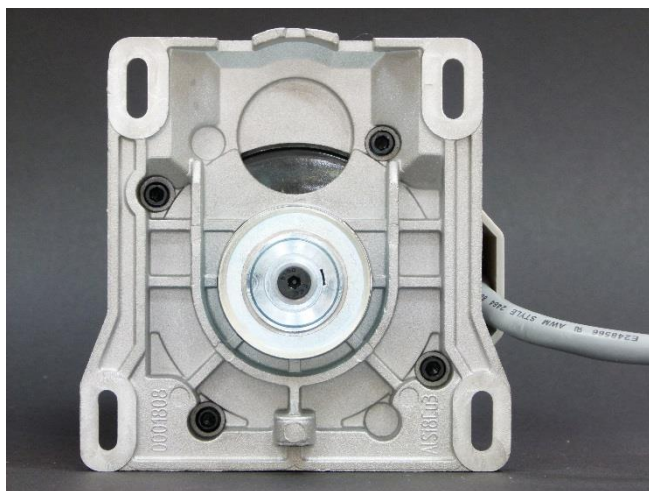
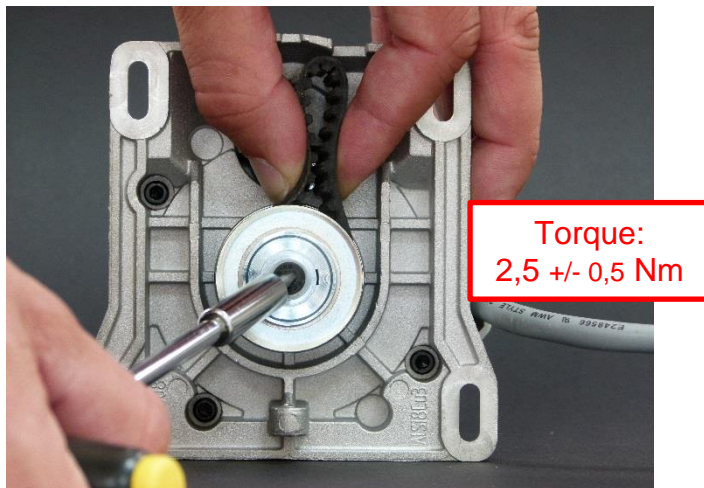

Efka motor DC1210 at sewing machine Pegasus EX

5 Mount motor on adapter

5.1 To fix the motor on the adapter, the motor has to be pre-assembled

- Toothed belt disc (Efka 0301009) is mounted on motor shaft
- Toothed belt (Efka 0901007) lays in the space, that is designed for the belt

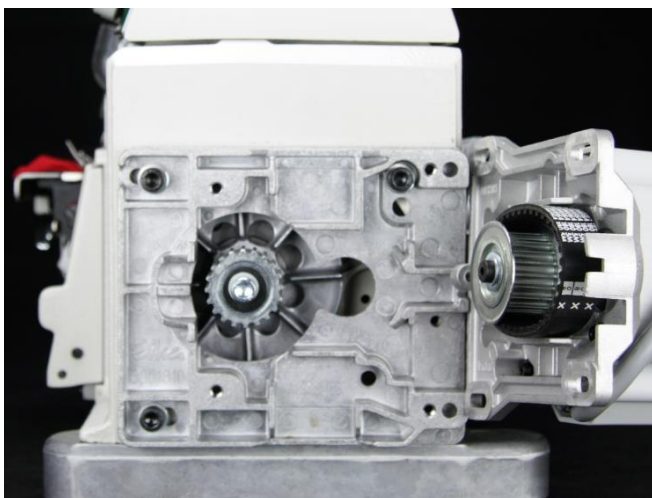

5.2 Mount motor with 4 screws at the adapter

- 4 pc. Screw DIN 7984 M5x12 (Efka 1300699)
- 4 pc. Washer DIN 125 A5,3 (Efka 1304133)
- 4 pc. Spring washer DIN 128 B5 (Efka 1304136)

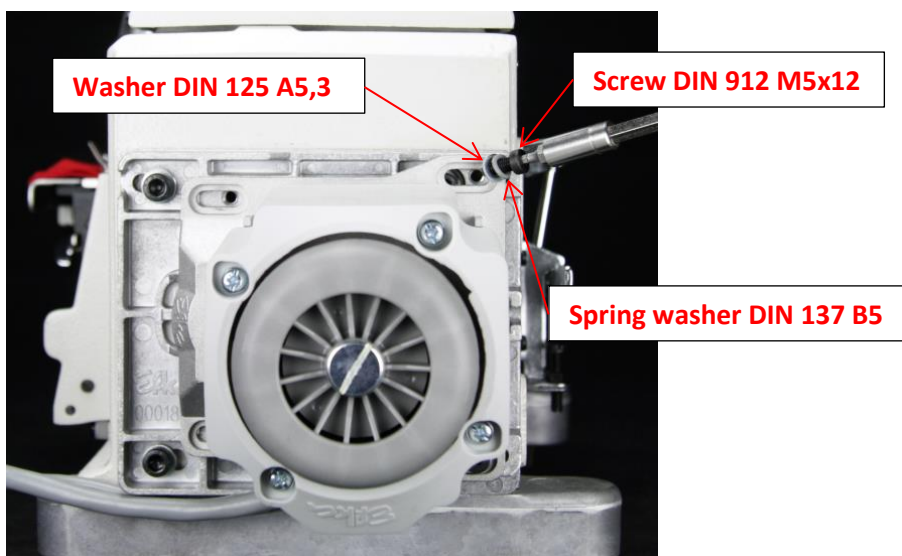

Do not fasten the screws! Motor has to move inside the oblong holes.

Efka motor DC1210 at sewing machine Pegasus EX



5.3 Insert the screw, that is used to stretch the belt

- 1 pc. Screw DIN 7984 M5x20 (Efka 1301077)
- 1 pc. Spring washer DIN 137 B5 (Efka 1300248)

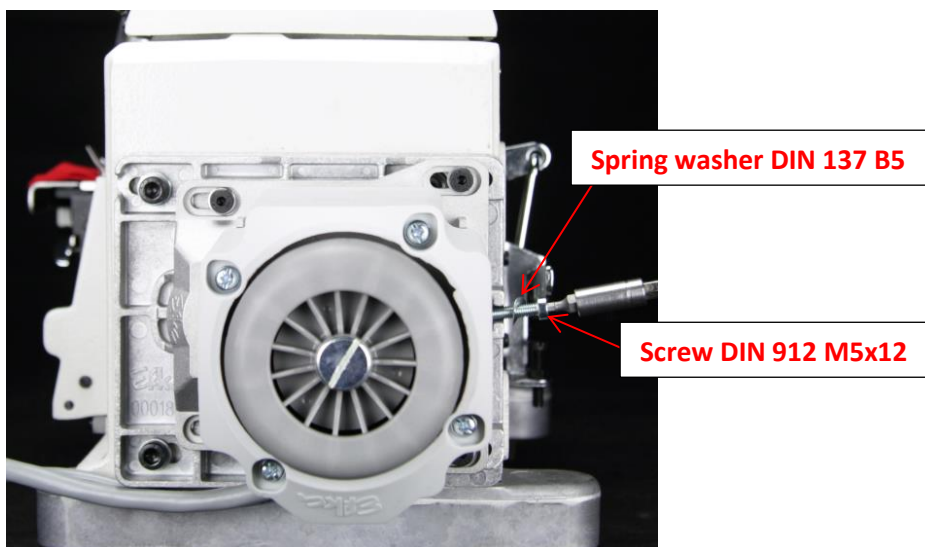

Efka motor DC1210 at sewing machine Pegasus EX

5.4 Adjust the motor

Turn handwheel and fasten the screw to stretch the belt.

If the strengt is too strong, while turning the handwheel, you can feel small interruptions. These interruption come from the theeth on wheel and belt.

Reduce the strength from this point just as much, that the belt turns without noticeable interruptions or additional force.

Let the motor turn electrically with the control box about 3000-4000 rpm. Listen to the noise of the motor and the belt. Find the point, where the noise grows up and stop the adjustment just before the noise increases. Target is, not to generate any additional noise from the toothed belt drive.

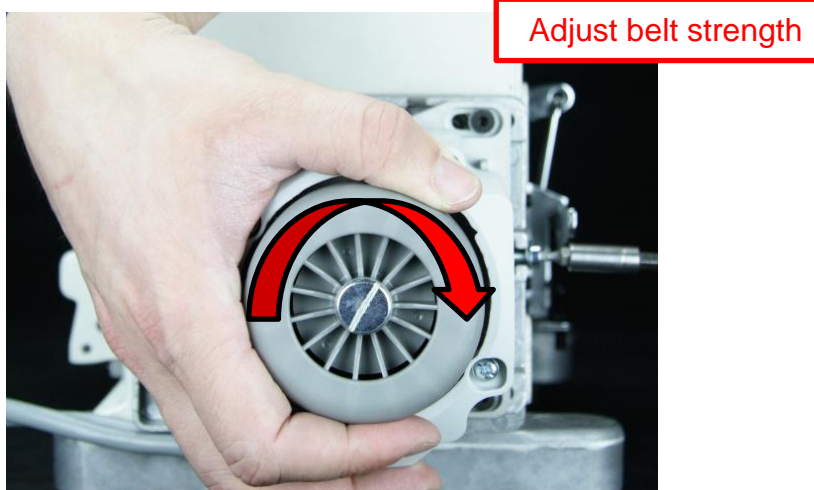

5.5 Fix the adjusted motor with all 4 screws on the adaper.

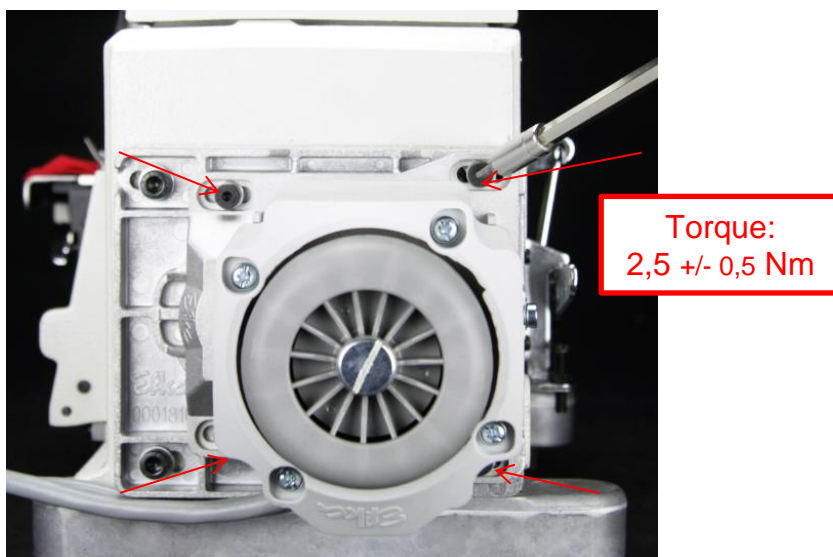

6 Insert air filter pad

6.1 Insert in every opening a filter pad 32x23x12mm (EFKA 0207272)

